

MODEL FP5000

008927
Issue 2

Configurable Pressure Transducer

DESCRIPTION

The Honeywell Model FP5000 Series is a media-isolated piezoresistive silicon pressure sensor offering multiple output options (0 V to 5 V, 0 V to 10 V or 4 mA to 20 mA) for reading pressure over the specified full-scale pressure span and temperature range. It is compensated for sensor offset, sensitivity, temperature effects and non-linearity to offer improved thermal stability and accuracy. Hastelloy® C276 and 316L stainless steel wetted parts provide durability with abrasive or corrosive media.

DIFFERENTIATION

- Offers improved accuracy and reliability
- Configurable platform enables a sensor to be built to customer requirements. Simplified nomenclature and order codes makes ordering easier
- Many pressure and operating temperature range options
- Built from stocked components; most configurations are shipped within ten business days
- Extensive history of pressure measurement know-how

VALUE TO CUSTOMERS

- Built on the Honeywell history of higher-quality pressure sensing technologies
- Next-gen design of the popular FP2000 pressure sensor
- Offers more repeatable, reliable, and accurate pressure measurements over time
- Rugged, stainless steel pressure sensors are built and tested to perform and survive in many demanding environments
- Configurable platform creates a wide range of standard configurations
- Stocked components enable shipping within ten business days on most configurations

FEATURES

- Pressure ranges from 10 in-H₂O [0.36 psi] up to 5000 psi
- Gage, absolute, vacuum, barometric and compound pressure types
- Higher accuracy to 0.1 %FSS BFSL
- Multiple output types: 0 Vdc to 5 Vdc, 0 Vdc to 10 Vdc, 4 mA to 20 mA
- Multiple electrical and pressure connection options
- Zero adjustment through potentiometer
- Operating temperature ranges from -40°C to 125°C [-40°F to 250°F]
- Multiple compensation temperature ranges
- Faster response and higher resolution
- Fully analog reduced-noise signal path provides continuous output resolution
- Stainless steel construction
- Ha C276 and 316L stainless steel wetted parts offer more enhanced durability with abrasive or corrosive media
- CE approved
- Intrinsically Safe: cFmus, ATEX, IEC Ex certified 2AR option (4 mA to 20 mA)



APPLICATIONS

- Test stands (Automotive, Aerospace, Industrial, and Medical)
- R&D test labs
- Hydraulic and pneumatic system monitoring
- Leak detection
- Manufacturing mold pressure control
- Pump and compressor control
- Liquid level measurement
- Oil & gas process control



PORTFOLIO

Model FP5000 pressure transducers are part of a comprehensive line of Honeywell pressure sensors.

Honeywell

CONFIGURABLE PRESSURE TRANSDUCER, MODEL FP5000

TABLE 1. PERFORMANCE SPECIFICATIONS

Characteristic	Measure
Operating pressure ranges	Gage: 10 in-H ₂ O [0.36 psi] to 5000 psi Absolute: 5 psi to 5000 psi Vacuum: 10 in-H ₂ O [0.36 psi] to 15 psi Barometric: 0 to 30 in-Hg, 16 to 32 in-Hg, 26 to 32 in-Hg Compound ranges available consult factory Equivalent ranges are available in other pressure units also: kPa, bar, mm-Hg, in-Hg, mbar, torr, in-H ₂ O
Accuracy ^{1,7}	0.2 %FSS BFSL (Standard accuracy) 0.1 %FSS BFSL (High accuracy)
Output (selectable)	0 Vdc to 5 Vdc, 0 Vdc to 10 Vdc, or 4 mA to 20 mA (two wire)
Resolution	Continuous (Fully analog signal path)

TABLE 2. ENVIRONMENTAL SPECIFICATIONS

Characteristic	Measure
Operating temperature range	See Table 3 (Electrical connectors)
Compensated temperature range	See Table 4 (Thermal effects error band)
Thermal effects error band (TEB) ^{2,3}	See Table 4 (Thermal effects error band)
Sealing	See Table 3 (Electrical connectors)

Notes:

1. Accuracies stated are with respect to best fit straight line (BFSL) for all errors including linearity, hysteresis, and non-repeatability through zero.
2. Thermal Effects Error Band - The maximum deviation in output due to changes in temperature over the entire compensated temperature range, relative to output measured at reference temperature. Includes all errors due to: Thermal Effect on Offset and Thermal Effect on Span.
3. Thermal effects error band (TEB) increases pro-rata for pressure ranges below 5 psi [0.35 bar].
4. True Zero Output: The voltage output versions have onboard circuitry that allows the output signal to swing all the way to ground (True Zero) and even a little below (~-0.2 V). This mitigates increased error at lower voltage measurements.
5. Over pressure: The absolute maximum rating for pressure which may be safely applied to the product for it to remain in specification once pressure is returned to the operating pressure range. Exposure to higher pressure may cause permanent damage to the product.
6. Burst pressure: The maximum pressure that may be applied to the product without causing escape of the pressure media. The product should not be expected to function after exposure to any pressure beyond the rated burst pressure.
7. All specifications apply at 25°C [77°F] and under operating conditions unless otherwise noted.
8. Full Scale Span (FSS): The algebraic difference between output signal measured at the upper and lower limits of the operating pressure range. Also known as "span".
9. Offset: The output signal obtained when the reference pressure is applied to all available pressure ports. Also known as "null" or "zero".
10. Reference pressure: The pressure used as a reference (zero) in measuring product performance. Unless otherwise specified, this is vacuum (0 psia) for absolute pressure sensors and local ambient atmospheric pressure (0 psig) for gage/vacuum pressure sensors.
11. Minimum operating pressure: The lower limit of the operating pressure range.

TABLE 3. ELECTRICAL CONNECTORS

Connector	Operating Temperature Range	Sealing
PT-02A-10-6P	-40°C to 125°C [-40°F to 250°F]	IP67
DIN FORM A	-40°C to 125°C [-40°F to 250°F]	IP65
DIN FORM C	-40°C to 90°C [-40°F to 194°F]	IP65
Integral cable	-40°C to 105°C [-40°F to 221°F]	IP67
Conduit fitting	-40°C to 105°C [-40°F to 221°F]	IP67
M12 x 1, 4-pin	-40°C to 85°C [-40°F to 185°F]	IP67

TABLE 4. THERMAL EFFECTS ERROR BAND (TEB)

Compensated Temperature Range	For Standard Accuracy	For High Accuracy
0° C to 60° C [40° F to 140° F]	< ±0.75 %FSS	< ±0.5 %FSS
-20° C to 80° C [0° F to 180° F]	< ±1.5 %FSS	< ±1 %FSS
-40° C to 85° C [-40° F to 185° F]	< ±2.25 %FSS	< ±1.5 %FSS
-40° C to 125° C [-40° F to 250° F]	< ±2.25 %FSS	< ±1.5 %FSS

TABLE 5. MECHANICAL SPECIFICATIONS

Characteristic	Measure
Media	Gas, liquid
Over pressure ⁵	
Operating ranges ≤ 15 psi (1 bar):	6X FS
15 psi (1 bar) < Operating ranges ≤ 1000 psi (70 bar):	4X FS
1000 psi (70 bar) < Operating ranges ≤ 5000 psi (350 bar):	3X FS or 10000 psi (700 bar) whichever is less
Burst pressure ⁶	
Operating ranges ≤ 15 psi (1 bar):	10X FS
15 psi (1 bar) < Operating ranges ≤ 1000 psi (70 bar):	6X FS
1000 psi (70 bar) < Operating ranges ≤ 5000 psi (350 bar):	4X FS or 10000 psi (700 bar) whichever is less
Weight (approx.)	150 g [5.3 oz]
Wetted parts material	Ha C276 and 316L stainless steel
Labels	Laser engraved

CONFIGURABLE PRESSURE TRANSDUCER, MODEL FP5000

TABLE 6. ELECTRICAL SPECIFICATIONS⁷

Specifications	2AM, 2AR: 4 mA to 20 mA (2 wire)	2AN: 0 V to 5 V (3 wire) ⁴	2AP: 0 V to 10 V (3 wire) ⁴
Supply voltage	9 Vdc to 28 Vdc	9 Vdc to 28 Vdc	14 Vdc to 28 Vdc
Current consumption	4 mA to 24 mA	< 6 mA	< 6 mA
Output at reference pressure ¹⁰ - (absolute, gage, vacuum)			
Output at minimum operating pressure ¹¹ - (compound, barometric)	4 mA ±0.5 %FSS	0 V ±0.5 %FSS	0 V ±0.5 %FSS
Full scale span (FSS) ⁸	16 mA ±1 %FSS	5 V ±1 %FSS	10 V ±1 %FSS
Frequency response	3500 Hz	3500 Hz	3500 Hz
Reverse voltage protection	Yes, 28 V	Yes, 28 V	Yes, 28 V
Load impedance	< 950 Ohm at 28 V decreasing linearly to 0 Ohm at 9 V	> 10K Ohms	> 10K Ohms
Insulation resistance	>500 MOhm to case GND at 33 V	>500 MOhm to case GND at 33 V	>500 MOhm to case GND at 33 V
Overvoltage protection	>32 V	>32 V	>32 V
Power up time	< 1 sec	< 1 sec	< 1 sec
Zero adjustment potentiometer	Yes, > ±5 %FS adjustment, accessible from top after demounting connector	Yes, > ±5 %FS adjustment, accessible from top after demounting connector	Yes, > ±5 %FS adjustment, accessible from top after demounting connector

CONFIGURABLE PRESSURE TRANSDUCER, MODEL FP5000

TABLE 7. DIN FORM A (6M), DIN FORM C (6BO) WIRING

PIN	STANDARD		ALTERNATIVE	
	4 mA to 20 mA (2AM, 2AR)	0 V to 5 V/0 V to 10 V (2AN, 2AP)	4 mA to 20 mA (2AM, 2AR)	0 V to 5 V/0 V to 10 V (2AN, 2AP)
	Designation	Designation	Designation	Designation
1	(+) Supply	(+) Supply	(+) Supply	(+) Supply
2	(+) Output	(+) Output	(+) Output	Supply return/ (-) Output
3	No connection	Supply return/ (-) Output	No connection	(+) Output
E	No connection	No connection	Case GND	Case GND

TABLE 8. PT02A-10-6P, 6-PIN (6A) WIRING

PIN	STANDARD		ALTERNATIVE	
	4 mA to 20 mA (2AM, 2AR)	0 V to 5 V/0 V to 10 V (2AN, 2AP)	4 mA to 20 mA (2AM, 2AR)	0 V to 5 V/0 V to 10 V (2AN, 2AP)
	Designation	Designation	Designation	Designation
A	(+) Supply	(+) Supply	(+) Supply	(+) Supply
B	No connection	Supply return	(+) Output	(+) Output
C	No connection	(-) Output	No connection	No connection
D	(+) Output	(+) Output	No connection	Supply return/ (-) Output
E	No connection	No connection	No connection	No connection
F	No connection	No connection	No connection	No connection

TABLE 9. INTEGRAL CABLE (6Q), CONDUIT FITTING (6R) WIRING

PIN	STANDARD		ALTERNATIVE	
	4 mA to 20 mA (2AM, 2AR)	0 V to 5 V/0 V to 10 V (2AN, 2AP)	4 mA to 20 mA (2AM, 2AR)	0 V to 5 V/0 V to 10 V (2AN, 2AP)
	Designation	Designation	Designation	Designation
Red	(+) Supply	(+) Supply	(+) Supply	(+) Supply
Black	(+) Output	Supply return	Not available	Supply return/ (-) Output
Green	Not available	(-) Output	Not available	Not available
White	Not available	(+) Output	(+) Output	(+) Output

TABLE 10. M12 X 1, 4-PIN (6BJ) WIRING

PIN	STANDARD		ALTERNATIVE	
	4 mA to 20 mA (2AM, 2AR)	0 V to 5 V/0 V to 10 V (2AN, 2AP)	4 mA to 20 mA (2AM, 2AR)	0 V to 5 V/0 V to 10 V (2AN, 2AP)
	Designation	Designation	Designation	Designation
1	(+) Supply	(+) Supply	(+) Supply	(+) Supply
2	No connection	(+) Output	(+) Output	No connection
3	(+) Output	Supply return/ (-) Output	No connection	Supply return/ (-) Output
4	Case GND	Case GND	Case GND	(+) Output

TABLE 11. INTRINSICALLY SAFE APPROVALS FOR OPTION 2AR (NOT AVAILABLE ON 2AM, 2AN, 2AP)

Agency	Approvals
cFMus	Class I, Div 1, Groups A, B, C, D Class I, Zone 0, AEx/Ex ia IIC T4/T5 Ga Ta= -40°C to 40°C (T5), -40°C to 85°C (T4)
ATEX	II 1 G Ex ia IIC T4/T5 Ga Ta= -40°C to 40°C (T5), -40°C to 85°C (T4)
IEC Ex	Ex ia IIC T4/T5 Ga Ta= -40°C to 40°C (T5), -40°C to 85°C (T4)

See Honeywell's website (<http://sensing.honeywell.com>) for up-to-date information regarding intrinsically safe approvals. Refer to Installation manual #008-0751-00 for installation/wiring instructions, cautions and warnings.

CONFIGURABLE PRESSURE TRANSDUCER, MODEL FP5000

Figure 2. Mounting Dimensions

ELECTRICAL TERMINATION

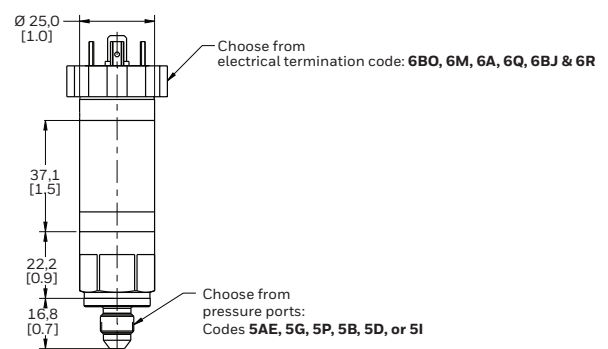
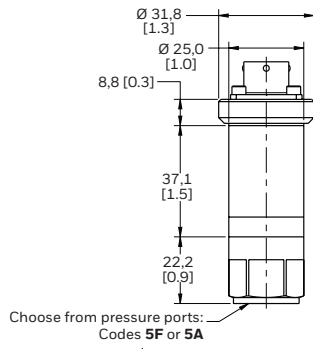
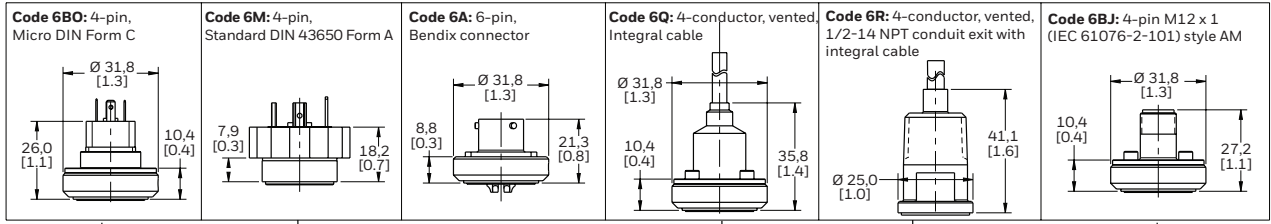

PRESSURE PORTS

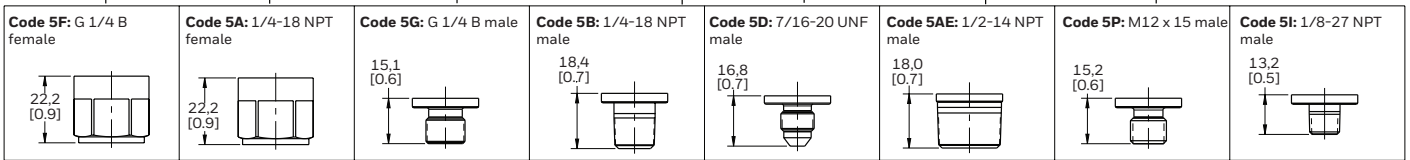

CAUTION

PRODUCT DAMAGE DUE TO MECHANICAL ISSUES

- Ensure torque specifications are determined for the specific application. (Mating materials and thread sealants can result in significantly different torque values from one application to the next.)
- When using mating parts made of stainless steel, use a thread sealant with anti-seize properties to prevent thread galling. Ensure the sealant is rated for the application.
- Use appropriate tools (such as an open-ended wrench or deep-well socket) to install transducers.
- Always hand-start transducers into the hole to prevent cross threading and damage.
- Ensure that torque is not applied to the electrical connector.
- Ensure that the proper mating electrical connector with a seal is used to connect the transducer. Improper or damaged seals can compromise ingress protection, leading to short circuits.
- To ensure proper environmental sealing and electrical connections when using a connector, follow the connector manufacturer's installation guidelines.
- All terminal cavities must be sealed using the correct wire gauge and seal combination.
- If only two leads are used, any additional terminal cavities should be sealed per the connector manufacturer's installation guide.
- Honeywell recommends using a crimping tool for crimping wires to the connector terminals.
- Contact the individual connector manufacturer for connector wiring.

Failure to comply with these instructions could result in product damage.

NOTICE

Refer installation manual #008-0751-00 for installation/wiring instructions, cautions and warnings related to Intrinsically Safe FP5000 (option 2AR).

FOR MORE INFORMATION

Honeywell Sensing and Internet of Things services its customers through a worldwide network of sales offices and distributors. For application assistance, current specifications, pricing, or the nearest Authorized Distributor, visit sensing.honeywell.com or call:

USA/Canada	+302 327 8920
Latin America	+1 305 805 8188
Europe	+1 302 327 8920
Japan	+81 (0) 3-6730-7152
Singapore	+65 6355 2828
Greater China	+86 4006396841

Honeywell Sensing and Internet of Things

830 East Arapaho Road
Richardson, TX 75081

WARNING PERSONAL INJURY

DO NOT USE these products as safety or emergency stop devices or in any other application where failure of the product could result in personal injury.

Failure to comply with these instructions could result in death or serious injury.

WARNING MISUSE OF DOCUMENTATION

- The information presented in this product sheet is for reference only. Do not use this document as a product installation guide.
- Complete installation, operation, and maintenance information is provided in the instructions supplied with each product.

Failure to comply with these instructions could result in death or serious injury.

Warranty/Remedy

Honeywell warrants goods of its manufacture as being free of defective materials and faulty workmanship during the applicable warranty period. Honeywell's standard product warranty applies unless agreed to otherwise by Honeywell in writing; please refer to your order acknowledgment or consult your local sales office for specific warranty details. If warranted goods are returned to Honeywell during the period of coverage, Honeywell will repair or replace, at its option, without charge those items that Honeywell, in its sole discretion, finds defective. **The foregoing is buyer's sole remedy and is in lieu of all other warranties, expressed or implied, including those of merchantability and fitness for a particular purpose. In no event shall Honeywell be liable for consequential, special, or indirect damages.**

While Honeywell may provide application assistance personally, through our literature and the Honeywell website, it is buyer's sole responsibility to determine the suitability of the product in the application.

Specifications may change without notice. The information we supply is believed to be accurate and reliable as of this writing. However, Honeywell assumes no responsibility for its use.

Hastelloy® is a registered trademark of Haynes International, Inc.

008927-2-EN | 2 | 07/20
© 2020 Honeywell International Inc.

Honeywell