

MeshGuard Network Deployment Guide



Network Configurations Using The FMC2000 Controller & MeshGuards



FMC2000 Controller



MeshGuard

The hub of any MeshGuard network is the FMC2000 wireless controller, which can act as the wireless base station for up to 24 MeshGuard monitors. Housed in stainless steel and equipped with a backup battery, the FMC 2000 is the ideal controller for MeshGuard systems used on drilling rigs and during plant maintenance operations requiring gas detection. Dependable and simple to install and operate, a MeshGuard network can be configured and reconfigured mostly by just physically relocating MeshGuard detectors.

MeshGuard RTR & STD Modes

MeshGuard can operate in either Router Mode (RTR) or Standard Mode (STD). In RTR, the modem is always on and data is constantly exchanged with the FMC2000, plus the MeshGuard can act as a router to extend the range between MeshGuards and the FMC2000.

In STD mode, the MeshGuard's modem is usually off, conserving power. The modem is turned on when an alarm occurs, plus it is turned on periodically to transmit data when no alarm is sounding. This keeps the FMC2000 informed of its online/offline status.

Note: When in STD mode, battery life in a MeshGuard EC is up to 6 months. In RTR mode, the battery life in a MeshGuard EC is up to 10 days.

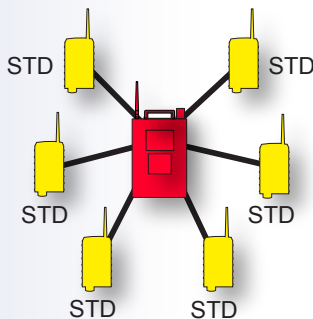

Standard Network

In a typical "star" configuration, MeshGuard monitors are in Standard Mode (STD) and only communicate with the FMC2000. The MeshGuards in the network do not communicate with each other or act as routers.

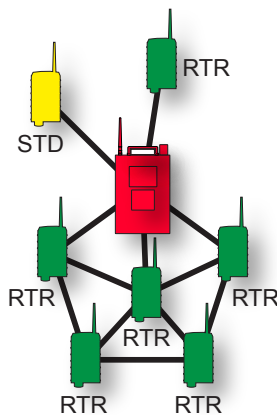

Mesh Network

In a mesh network, MeshGuards set in Router Mode (RTR) are capable of communicating not only with the FMC2000 base station, but with each other, so that obstacles are more easily overcome, and if any monitors go offline, the network "heals" itself. Finally, when a MeshGuard is in RTR Mode, its modem is always on, so real-time data is always being delivered to the FMC2000.

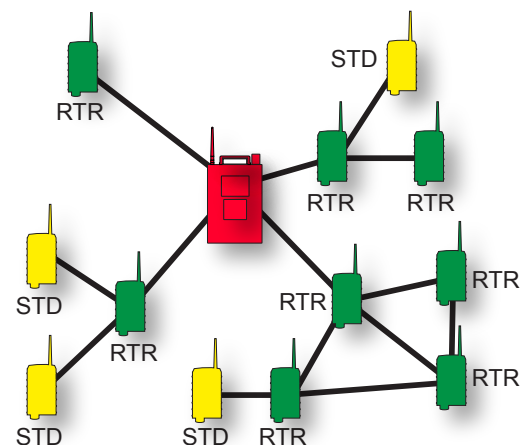

Hybrid Network

Because the FMC2000 can communicate with MeshGuards in both RTR and STD modes simultaneously, multiple "subnetworks" and mixed networks can be used. The example shown here has four "subnetworks," with the MeshGuards in RTR Mode acting as routers for those in STD Mode, as well as providing real-time data to the FMC2000 at all times.

MeshGuard Network Deployment Guide

FMC2000 Installation

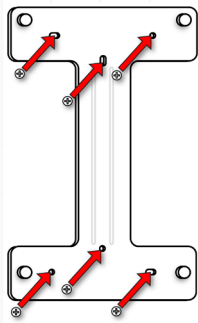

Attach mounting bracket to wall using six screws.

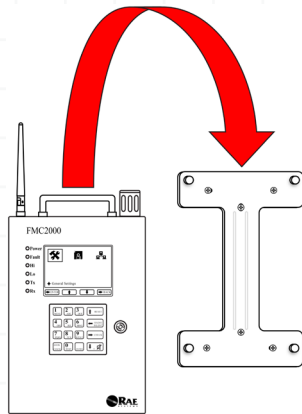

Set FMC2000 onto mounting bracket.

FMC2000 Wiring

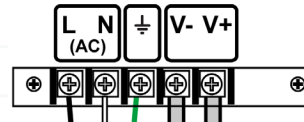

Connect AC (mains) wires to AC power source.

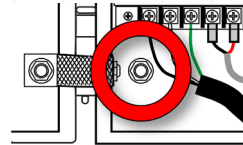

The ground point (circled) uses a bolt to hold a ground wire in place. Follow all local code guidelines.

12	NO	
11	COM	RELAY 4
10	NC	
9	NO	
8	COM	RELAY 3
7	NC	
6	NO	
5	COM	RELAY 2
4	NC	
3	NO	
2	COM	RELAY 1
1	NC	

Four relays have identical wiring (Normally Open, Normally Closed, Common). Relay 1 is for Low Alarm; Relays 2 - 4 are for High Alarm.

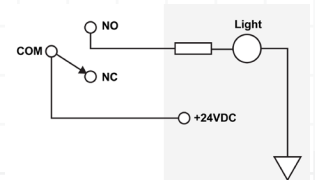

Startup Sequence

Turn on the FMC2000 and allow it to go through its startup routine before turning on MeshGuard detectors.

Turning FMC2000 On

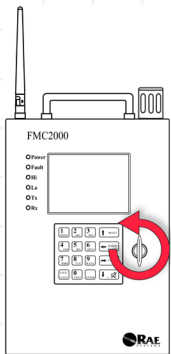

Use key to unlock the front door. Turn 90° counter-clockwise.

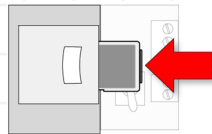

Make sure a formatted SD card is in its slot on the main circuit board.

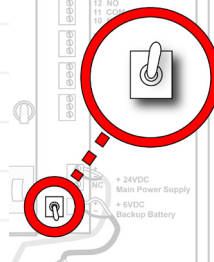

Toggle the switch next to the main circuit board from down to up (on).

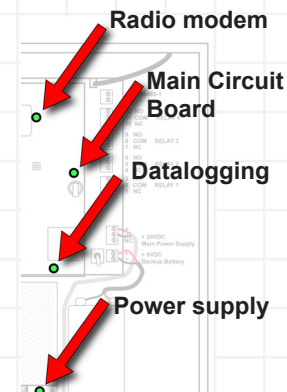

Power supply and main circuit board LEDs should glow. Radio modem and datalogging may be off, so LEDs may not glow.

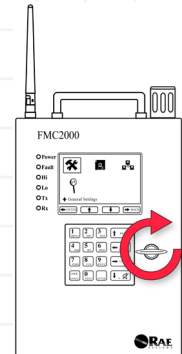

Use key to lock the front door. Turn 90° clockwise.

The MeshGuard User's Guide and FMC2000 User's Guide, which accompany their respective products, must be carefully read by all individuals who have or will have the responsibility of using, maintaining, or servicing these products. These products will perform as designed only if used, maintained, and serviced in accordance with the manufacturer's instructions. The user should understand how to set the correct parameters and interpret the obtained results.

MeshGuard Network Deployment Guide

Turning MeshGuard On/Off

Hold down the [MODE] key and release it when the MeshGuard beeps. The monitor is now on, and goes through diagnostics and network connection. When the reading display is shown, the MeshGuard is ready for use.

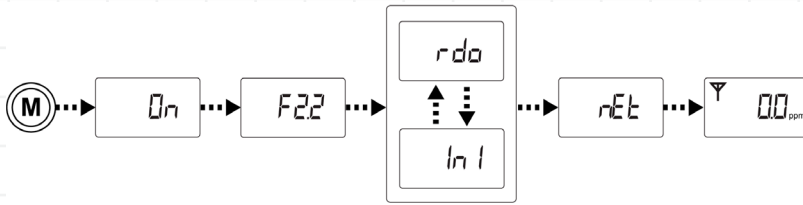

If MeshGuard finds and joins a wireless network, the antenna icon is shown in the display. If no antenna icon appears, press [Y/+] to search for a network.

Note: A flashing antenna means the MeshGuard is in Router Mode (RTR), and the radio is always on, which reduces battery life, compared to STD.

To turn MeshGuard Off: Press and hold [MODE] through its count-down to zero. When it beeps, release the key. The MeshGuard is now off.

Difficulty Finding A Network?

If an antenna icon is not showing in the MeshGuard's display, press [Y/+]. MeshGuard automatically searches for a network, and joins it. While searching, the display alternates between "rdo" and "rsh" and then "lnl" and "nEt" as it joins the network.



It may be necessary to relocate the MeshGuard so that it is closer to the FMC2000, or has better line of sight and linking quality. It is possible that an optional extension antenna might be necessary.

If no network is found, or one cannot be joined, refer to the User's Guide for troubleshooting details.

Note: A flashing antenna icon means the MeshGuard is in RTR mode. Otherwise, it is in STD.

MeshGuard Installation

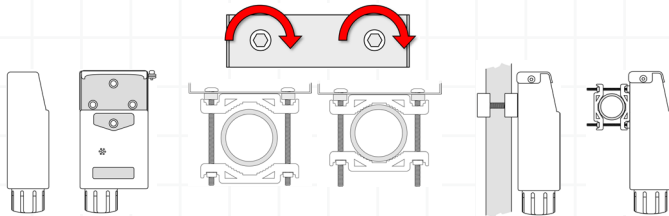

For stationary installation, secure the metal enclosure to a pole by placing the clamp around the pole and tightening the screws and tensioning the clamp.

After the enclosure is securely fastened, open the top, insert the MeshGuard, and close the top. Tighten the screw that locks the top in place.

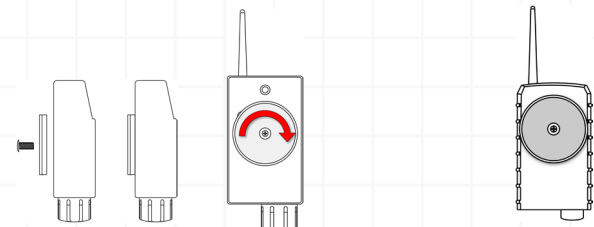
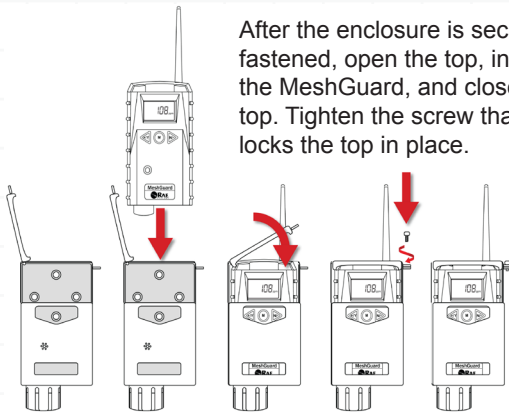

For temporary or easily reconfigured systems, a round magnetic disc can be screwed into the back of the metal enclosure, or directly into the back of the MeshGuard.

RTR/STD Mode Selection

A MeshGuard can operate in one of two modes: Router Mode and Standard Mode (RTR and STD, respectively). The default is STD, which only activates the modem when the MeshGuard is in alarm. This provides the benefit of maximizing battery life.

In RTR mode, the MeshGuard's modem is always on. While this reduces battery life, it is in constant communication with the base-station FMC2000, as well as any other MeshGuards in the network that are configured in RTR mode. In addition, an RTR-configured MeshGuard can act as a router in a network, extending the range between other MeshGuards (in RTR or STD mode) and the base station FMC2000.

1. Press and hold [MODE] and [Y/+] to turn the MeshGuard on.
2. Press and hold [MODE] and [N/-] until you see "Pro."
3. Step through programmable functions by pressing [N/-].
4. When the screen shows the current mode, "STD En" or "RTR En" (for STD enabled or RTR enabled), toggle the mode by pressing [Y/+].
5. Exit by pressing and holding [Y/+] and [MODE].

MeshGuard Battery Life

The battery is designed for up to six months' life in STD mode, up to 10 days in RTR mode. When the battery gets low, the MeshGuard beeps once per minute. It is recommended that the battery be changed immediately, to minimize disruption.



When battery is completely depleted, the LCD displays "OFF," and the LED, buzzer and vibration alarm activate once per second. The battery icon also blinks on and off. The MeshGuard shuts down after you press any key, or shuts down automatically if you do not press a key for 60 seconds.

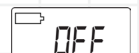

MeshGuard Network Deployment Guide

Configuring The FMC2000

1. From Normal Operation Mode, press Menu.
2. Supply the basic password (the default is 1234) followed by Enter.
3. At Basic Settings, press Enter.
4. At Date Format, select Enter to edit, or press the down arrow to bypass.
5. If Enter was used, press the down arrow to select, and then press Enter to register a change.
6. Press Back to return to the menus.
7. Press the down arrow to get to Date.
8. Press Enter to change the date, or press the down arrow to bypass.
9. If Enter was used, use the numerical keypad to set the date or up/down arrow to move cursor.
10. When done, press Enter.
11. Press the back arrow to return to the menus.

Note: Follow this procedure for each of the editable functions.

MeshGuard Bump Test

All newly purchased RAE Systems instruments should be bump tested by exposing the sensor(s) to known concentration calibration gas. A bump test is defined as a brief exposure of the monitor to the calibration gas and the sensors to show response and trigger the lowest alarm set point for each sensor.

- The monitor should be calibrated if it does not pass a bump test, but no less than every 6 months, depending on use and exposure to gas and contamination, and its operational mode.
- Calibration intervals and bump test procedures may vary due to national legislation.

Naming A MeshGuard

The FMC2000 lets you name each MeshGuard on a network. Follow this procedure:

1. From Normal Operation Mode, press Menu.
2. Supply the basic password (the default is 1234) followed by Enter.
3. At Basic Settings, press Enter.
4. Press down arrow twice to reach Wireless Settings.
5. Press Enter to reach Location.
6. Press Enter.
7. Type in a name (up to 8 characters).
8. When done, press Enter.
9. To exit, press Exit.

System Troubleshooting

- Double-check wiring and the line-of-sight distance between the MeshGuards and the FMC2000 controller.
- Move the MeshGuards closer to the FMC2000 to see whether connections are established.
- Check the PanID. It must be the same on both the MeshGuard and the FMC2000 controller.
- Check the batteries in the MeshGuards. Note that MeshGuards operating in RTR mode deplete batteries fastest.
- Reboot the FMC2000 (turn it off and on again), and then restart each MeshGuard.
- Place FMC2000 and/or MeshGuards higher off the ground, or use optional extension antenna and locate at higher position.
- If obstacles cannot be avoided, deploy a MeshGuard in RTR mode to act as a router.
- If operating in an electronically noisy environment, search for the best available channel. Consult the User's Guide for details.
- Add an extra MeshGuard.

MeshGuard Detection Mode

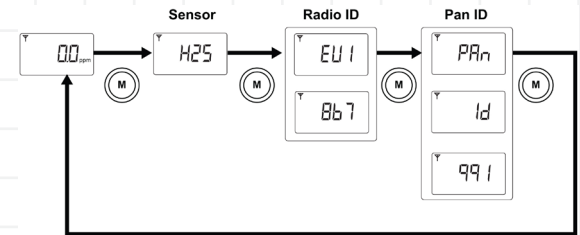

The MeshGuard's normal operating mode is Detection Mode. Step through the basic screens by pressing [MODE] to see the sensor type, Radio ID, and Pan ID.

MeshGuard Diagnostic/Programming Mode

Press and hold [Y/+] and [MODE] to enter Diagnostic Mode.

1. When you see "rAU," press and hold [MODE] and [N/-] until you see "Pro."
2. Step through programmable functions by pressing [N/-].
3. Make a change by pressing [Y/+].
4. Exit by pressing and holding [Y/+] and [MODE].

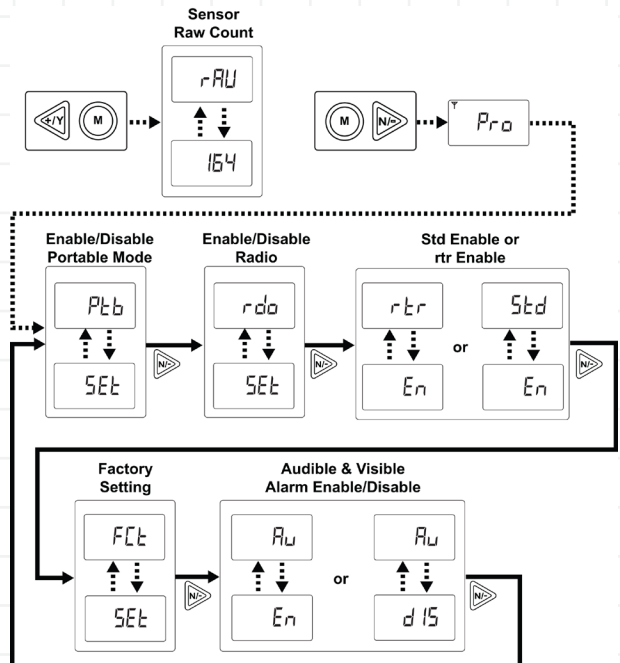

Note: Portable Mode does not apply to MeshGuard LEL.

MeshGuard Network Deployment Guide

Basic FMC2000 Navigation

Most navigation within the FMC2000 can be done by following the chart below. At some points, a standard password of 4 digits (default value of 1234) and an advanced 6-digit password (default value of 123456) is necessary. When prompted for a password or other numerical value, use the numerical keys followed by the ENTER key. Refer to the User's Guide for in-depth instruction for each submenu.

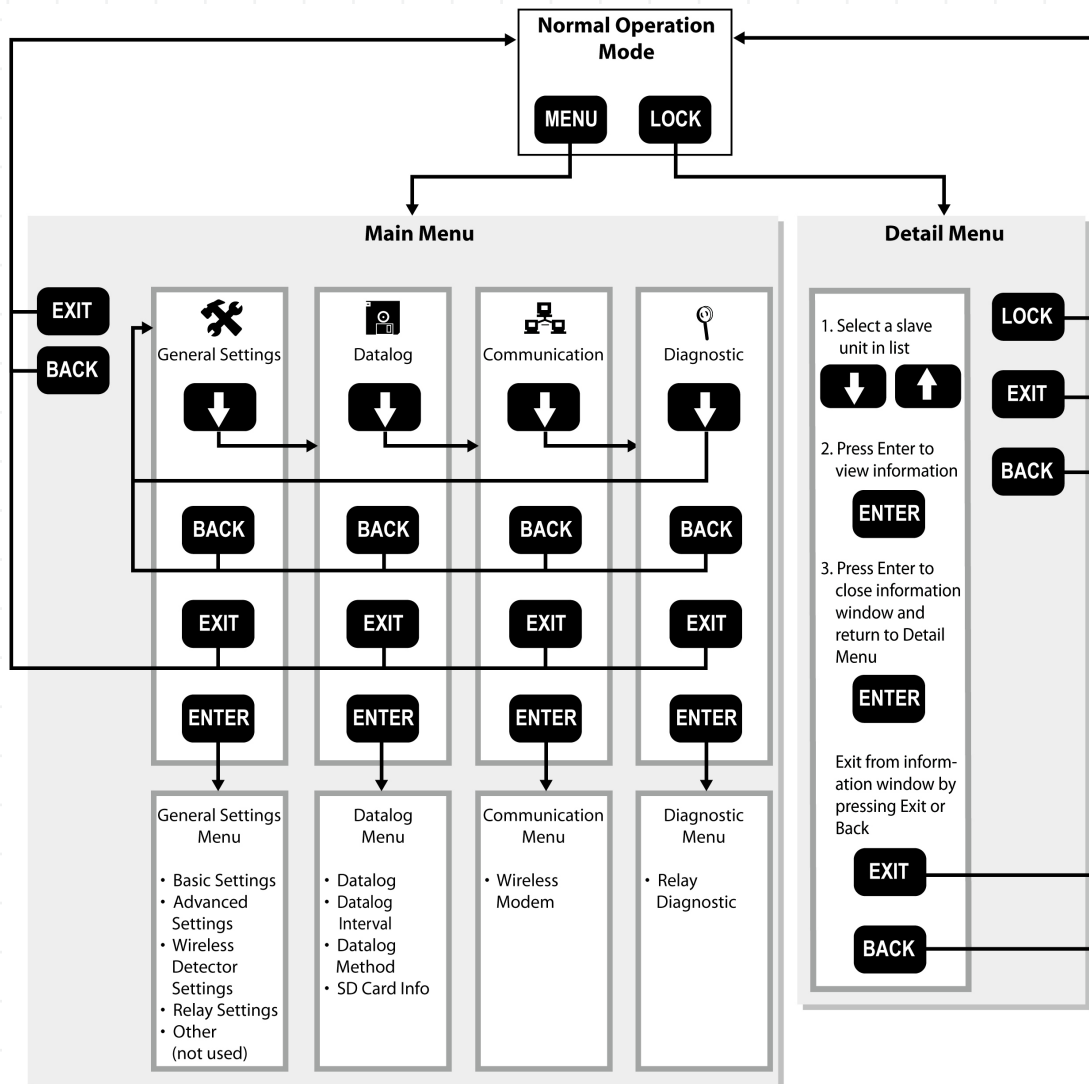

Set PAN ID

1. From Normal Operation Mode, press Menu.
2. Enter the 4-digit password followed by Enter.
3. Press the Down Arrow until Communication is selected.
4. Select Wireless Modem by pressing Enter.
5. Press Down Arrow until Radio PanID is selected.
(The current Pan ID is shown.)

Change PAN ID

1. Press Enter. A box appears, saying "PanID(0~999):"
This prompts you to set a Pan ID number.
2. Set a Pan ID number using the number keys on the keypad.
3. Press Enter to make and save a selection.



RAE Systems by Honeywell 3775 N. First St., San Jose, CA 95134-1708 USA

Web: www.raesystems.com • Tech Support Email: tech@raesystems.com • Tech Support Phone: +1 408-952-8461

Rev C, Sept. 2010 P/N: D01-4013-000

MeshGuard Network Deployment Guide

MeshGuard Programming

MeshGuard allows you to step through programming screens and set parameters.

- Enter Programming Mode by turning on the MeshGuard and then holding down [MODE] and [N/-] until “Pro” appears in the display.
- Step from one set of parameters to the next by pressing [N/-].
- Enter a submenu to make changes by pressing [Y/+].
- Exit to Detection Mode by pressing [MODE].

Detailed descriptions of all programming functions are covered in the MeshGuard User’s Guide.

Note: Portable Mode does not apply to MeshGuard LEL.

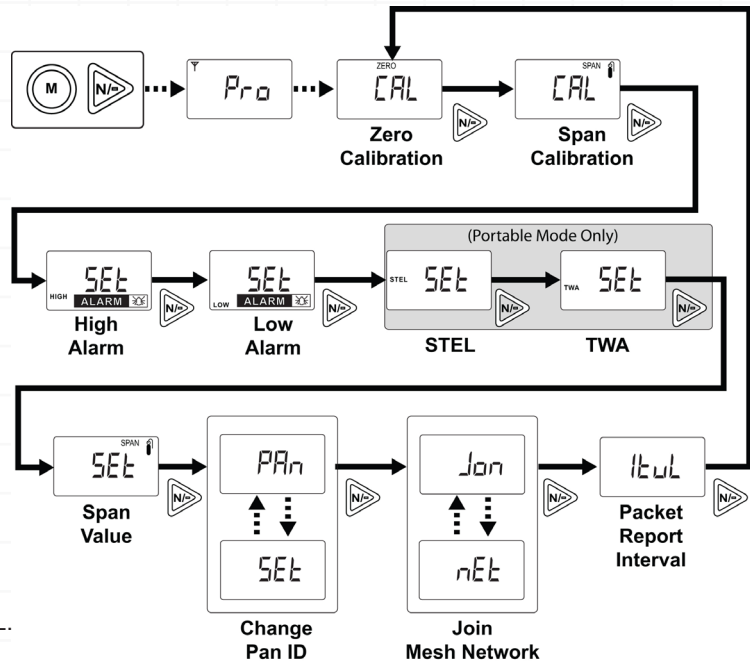

MeshGuard Zero Calibration

1. From Detection Mode, press and hold [MODE] and [N/-] to enter Programming Mode. When you see “Pro,” release the keys.
2. When “CAL” and “go” are displayed, and “ZERO” is shown, the MeshGuard is ready to perform a zero (fresh air) calibration.
3. Press [Y/+]. The LCD displays “go.” The display counts down from 10 to 0.
4. After the countdown reaches 0, the LCD displays “dn,” for “done.” The reading should show 0. Otherwise, repeat the zero calibration.

MeshGuard Span Calibration

1. Attach a cylinder of calibration gas to the calibration adapter, and attach the calibration adapter to the MeshGuard’s sensor.
2. From Detection Mode, press and hold [MODE] and [N/-] to enter Programming Mode. When you see “Pro,” release the keys.
3. When “CAL” and “go” are displayed in alternation, press [N/-]. The display shows “CAL” and “go” in alternation, with the word “SPAN” shown along the top. The MeshGuard is ready to perform a span calibration.
4. Press [Y/+]. The LCD displays “go.” Connect the calibration gas adapter to the MeshGuard, and connect the gas cylinder to the adapter. Start the flow of gas.
5. When the gas flow starts, the LCD displays “gAS” and the span concentration value.
6. After the countdown reaches 0, the LCD displays “dn,” for “done.” The reading should equal the span gas’ concentration value. Otherwise, repeat the span calibration.

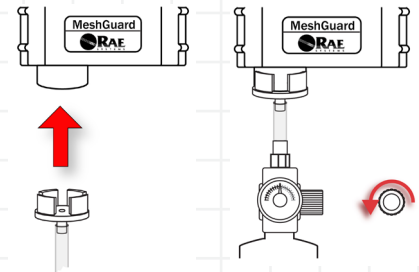

If the MeshGuard does not detect gas after counting down to 0, the LCD displays “Err” (for “error”). The LED glows red and the buzzer sounds to provide extra warning. The MeshGuard automatically returns to the span calibration display.

Setting MeshGuard Low Alarm, High Alarm, And Span Values

1. From Detection Mode, press and hold [MODE] and [N/-] to enter Programming Mode. When you see “Pro,” release the keys.
2. When “CAL” and “go” are displayed, press [N/-] until the display shows the High Alarm, Low Alarm, or Span Set screen.
3. Press [Y/+] to enter and change the setting. Press [MODE] to go back to Detection Mode or [N] to advance to the next menu.
4. The LCD displays the current value. Change the value if necessary.
To change the value:
 1. Press [Y/+] to increase the number and [N/-] to decrease it.
 2. Press [MODE] to advance to the next digit.
 3. After moving to the last digit and making changes, press [MODE]. A question mark (?) is shown in the display, asking if you want to save the change.
 - Press [Y/+] for yes. The message “dn” means the change is done.
 - Press [N/-] for no. A “no” message means that the change was abandoned.
 - Press [MODE] to return to the first digit.