

# AreaRAE

## Wireless Multi-Gas Monitor

Includes AreaRAE, AreaRAE Gamma,  
AreaRAE Gamma Steel,  
And AreaRAE Steel



## Operation & Maintenance Manual

Document Number: 029-4034-000

Revision B, May 2008



This product may be covered by one or more of the following U.S. Patents:  
5,393,979      5,561,344      5,773,833      6,225,633  
6,313,638      6,333,632      6,320,388

## - READ BEFORE OPERATING -

This manual must be carefully read by **ALL** individuals who have or will have the responsibility for using, maintaining, or servicing this product. The product will perform as designed only if it is used, maintained, and serviced in accordance with the manufacturer's instructions.

When the AreaRAE is removed from the transport case and turned on for the first time, there may be residual organic or inorganic vapor trapped inside the detector chamber. The initial PID or toxic sensor reading may indicate a few ppm. Ensure an area free of organic or toxic vapors and turn the monitor on. After running the monitor for several minutes, the residual vapor in the detector chamber should clear, and the reading should return to zero.

The battery of the AreaRAE slowly drains even when it is not on. If the monitor has not been charged for 5 to 7 days, the battery voltage will be low. Therefore, it is good practice to charge the monitor before each use. It is also recommended to fully charge the monitor for **AT LEAST 10 HOURS** before initial use. See Section 6 for more information on battery charging and replacement.

### **CAUTION!**

<p>To reduce the risk of electric shock, turn the power off before opening the monitor cover. Disconnect the battery before removing sensor module for service. Never operate the monitor when the cover is removed. Remove monitor cover and sensor module only in an area known to be non-hazardous.</p>
--

**AreaRAE, AreaRAE Gamma, AreaRAE Steel, and AreaRAE Gamma Steel Multi-Gas Monitors are certified for:**  
CSA Canada/USA Class I, Division 2, Groups A, B, C, D

**The AreaRAE Steel and AreaRAE Gamma steel Multi-Gas Monitor are also certified for:**  
EX II 3G EEx nAL IIC T6

## AreaRAE & AreaRAE Gamma



Use only RAE Systems rechargeable battery pack part number 029-3051-000/029-3151-000, or alkaline battery pack part number 029-3052-000/029-3152-000. Use only DURACELL Mn1400 or ENERGIZER E93 C size batteries with alkaline battery pack. This instrument has not been tested in an explosive gas/air atmosphere having an oxygen concentration greater than 21%. Substitution of components may impair suitability for Class I, Division 2. Recharge/replace batteries only in non-hazardous locations. Do not connect the serial communication port in a hazardous location.

**STATIC HAZARD:** Clean only with a damp cloth.

For safety reasons this equipment must be operated and serviced by qualified personnel only. Read and understand instruction manual completely before operating or servicing.

Only the combustible gas detection portion of this instrument has been assessed for performance.

Before each day's usage, sensitivity must be tested on a known concentration of methane gas equivalent to 20% to 50% of full-scale concentration. Accuracy must be within  $\pm 20\%$  of actual. Accuracy may be corrected by calibration procedure.

Any rapid up-scale reading followed by a declining or erratic reading may indicate a gas concentration beyond upper scale limit which may be hazardous.

The calibration of all newly purchased RAE Systems instruments should be tested by exposing the sensor(s) to known concentration calibration gas before the instrument is used or put into service. For maximum safety, the accuracy of the AreaRAE and AreaRAE Gamma should be checked by exposing the sensor(s) to known concentration calibration gas before each day's use.

## AreaRAE & AreaRAE Gamma



Utiliser seulement l'ensemble de batterie RAE Systems, la référence 029-3051-000/029-3151-000 ou 029-3052-000/029-3152-000. Cet instrument n'a pas été essayé dans une atmosphère de gaz/air explosive ayant une concentration d'oxygène plus élevée que 21%. La substitution de composants peut compromettre la sécurité intrinsèque. Ne charger les batteries que dans un emplacement désigné non dangereux. Ne reliez pas le port de communication périodique dans un endroit dangereux.

### **DANGER RISQUE D'ORIGINE ELECTROSTATIQUE:**

Nettoyer uniquement avec un chiffon humide.

Pour des raisons de sécurité, cet équipement doit être utilisé, entretenu et réparé uniquement par un personnel qualifié. Étudier le manuel d'instructions en entier avant d'utiliser, d'entretenir ou de réparer l'équipement.

Uniquement, la portion pour détecter les gaz combustibles de cet instrument a été évaluée.

Avant chaque utilisation journalière vérifier la sensibilité avec une concentration connue de méthane équivalente à 20-50% de la pleine échelle. La précision doit être comprise entre  $\pm 20\%$  de la valeur vraie et peut être corrigée par une procédure de recalibrage.

Toute lecture rapide et positive, suivie d'une baisse subite au erratique de la valeur, peut indiquer une concentration de gaz hors gamme de détection qui peut être dangereuse.

La calibration de toute instruments de RAE Systems doit être testé en exposant l'instrument à une concentration de gaz connue par une procédure de recalibrage avant de mettre en service l'instrument pour la première fois. Pour une sécurité maximale, la sensibilité du AreaRAE et AreaRAE-Gamma doit être vérifié en exposant l'instrument à une concentration de gaz connue par une procédure de recalibrage avant chaque utilisation journalière.

## AreaRAE Steel & AreaRAE Gamma Steel



**Explosion Hazard** – Substitution of components may impair suitability for Division 2 hazardous locations.

Use only RAE Systems rechargeable battery pack part number 029-3153-200/029-3153-000 (ATEX only), or alkaline battery pack part number 029-3154-000. Use only DURACELL MN1400 or ENERGIZER E93 C size batteries with alkaline battery pack. This instrument has not been tested in an explosive gas/air atmosphere having an oxygen concentration greater than 21%. Substitution of components may impair safety. Recharge/replace batteries only in non-hazardous locations.

**STATIC HAZARD:** Clean only with a damp cloth.

For safety reasons this equipment must be operated and serviced by qualified personnel only. Read and understand instruction manual completely before operating or servicing.

Only the combustible gas detection portion of this instrument has been assessed for performance.

Before each day's usage, sensitivity must be tested on a known concentration of methane gas equivalent to 20% to 50% of full-scale concentration. Accuracy must be within  $\pm 20\%$  of actual. Accuracy may be corrected by calibration procedure.

Any rapid up-scale reading followed by a declining or erratic reading may indicate a gas concentration beyond upper scale limit which may be hazardous.

The calibration of all newly purchased RAE Systems instruments should be tested by exposing the sensor(s) to known concentration calibration gas before the instrument is used or put into service. For maximum safety, the accuracy of the AreaRAE Steel should be checked by exposing the sensor(s) to known concentration calibration gas before each day's use.

## AreaRAE Steel & AreaRAE Gamma Steel



**Risque d'explosion** – la substitution de composants pourrait altérer la compatibilité pour les zones dangereuses de division 2.

Utiliser seulement l'ensemble de batterie RAE Systems, la référence 029-3153-200/029-3153-000 (ATEX only) ou 029-3154-000. Cet instrument n'a pas été essayé dans une atmosphère de gaz/air explosive ayant une concentration d'oxygène plus élevée que 21%. La substitution de composants peut compromettre la sécurité. Ne charger les batteries que dans un emplacement désigné non dangereux.

### **DANGER RISQUE D'ORIGINE ELECTROSTATIQUE:**

Nettoyer uniquement avec un chiffon humide.

Pour des raisons de sécurité, cet équipement doit être utilisé, entretenu et réparé uniquement par un personnel qualifié. Étudier le manuel d'instructions en entier avant d'utiliser, d'entretenir ou de réparer l'équipement.

Uniquement, la portion pour détecter les gaz combustibles de cet instrument a été évaluée.

Avant chaque utilisation journalière vérifier la sensibilité avec une concentration connue de méthane équivalente à 20-50% de la pleine échelle. La précision doit être comprise entre  $\pm 20\%$  de la valeur vraie et peut être corrigée par une procédure de recalibrage.

Toute lecture rapide et positive, suivie d'une baisse subite ou erratique de la valeur, peut indiquer une concentration de gaz hors gamme de détection qui peut être dangereuse.

La calibration de tous les instruments de RAE Systems doit être testée en exposant l'instrument à une concentration de gaz connue par une procédure de recalibrage avant de mettre en service l'instrument pour la première fois. Pour une sécurité maximale, la sensibilité du the AreaRAE Steel doit être vérifiée en exposant l'instrument à une concentration de gaz connue par une procédure de recalibrage avant chaque utilisation journalière.

## TABLE OF CONTENTS

---

<b>1. General Information</b>	<b>1-1</b>
1.1 AreaRAE & AreaRAE Steel Specifications	1-3
1.2 AreaRAE Gamma & AreaRAE Gamma Steel Specifications	1-6
1.3 Radio Specifications – 869 MHz models	1-9
1.4 Radio Specifications – 900 MHz models	1-10
1.5 Radio Specifications – 2.4 GHz models	1-11
<b>2. Operation of the AreaRAE</b>	<b>2-1</b>
2.1 Physical Description	2-2
2.1.1 AreaRAE & AreaRAE Gamma	2-2
2.1.2 AreaRAE Steel & AreaRAE Gamma Steel	2-5
2.2 Keys and Displays	2-8
2.3 Turn Power On/Off	2-9
2.4 Data Protection	2-10
2.5 Operation Modes	2-11
2.5.1 Text Mode	2-12
2.5.2 Display Mode	2-13
2.5.3 Program Mode	2-18
2.6 Alarm Signals	2-20
2.7 Backlight	2-22
2.8 Preset Alarm Limits & Calibration	2-23
2.9 Integrated Sampling Pump	2-24
2.10 Datalogging	2-25
<b>3. Operation of Accessories</b>	<b>3-1</b>
3.1 Battery Charging Operation	3-2
3.2 Interchangeable Battery Packs	3-3
3.2.1 AreaRAE & AreaRAE Gamma	3-3
3.2.2 AreaRAE Steel & AreaRAE Gamma Steel	3-4
3.3 External Filter	3-7
3.4 Remote Sampling Probe	3-7
3.5 Dilution Fitting	3-8
3.6 Calibration Adapter	3-8
<b>4. Programming the AreaRAE</b>	<b>4-1</b>
4.1 Program Mode	4-2
4.2 Keys for Program Mode	4-4
4.3 Entering Program Mode	4-5
4.4 Calibrating the AreaRAE Steel	4-7

## TABLE OF CONTENTS

---

4.4.1	Fresh Air Calibration	4-8
4.4.2	Sensor Calibration Time	4-9
4.4.3	Multiple-Sensor Calibration	4-10
4.4.4	Single-Sensor Calibration	4-13
4.4.5	Modify Span Gas Value	4-15
4.4.6	Change LEL/VOC Span Gas	4-16
4.5	Change Alarm Limits	4-18
4.6	Change Datalog	4-20
4.6.1	Clear All Data	4-21
4.6.2	Change Datalog Period	4-22
4.6.3	Select Data Type	4-23
4.6.4	Enable/Disable Datalog	4-24
4.7	Change Monitor Setup	4-25
4.7.1	Change Site ID	4-26
4.7.2	Change User ID	4-27
4.7.3	Change Alarm Mode	4-28
4.7.4	Change User Mode	4-29
4.7.5	Change Real-time Clock	4-30
4.7.6	Change Light and Buzzer Mode	4-31
4.7.7	Change Password	4-32
4.7.8	Change Pump Duty Cycle	4-33
4.7.9	Change Pump Speed	4-34
4.7.10	Change Averaging Method	4-35
4.7.11	Change Display Language	4-36
4.7.12	Set Temperature Unit	4-37
4.8	Change Sensor Configuration	4-38
4.8.1	Correction Factors	4-39
4.8.2	Change LEL/VOC Gas Selection	4-40
4.8.3	Enable/Disable Sensor	4-43
4.8.4	Change Dilution Ratio	4-44
4.8.5	Change PID Lamp Type	4-45
4.8.6	Change RAD Unit (Gamma Models Only)	4-45
4.9	Exit Program Mode	4-46
<b>5.</b>	<b>Theory of Operation</b>	<b>5-1</b>
<b>6.</b>	<b>Maintenance Of AreaRAE &amp; AreaRAE Gamma</b>	<b>6-1</b>
6.1	Battery Replacement	6-2
6.2	Sensor Replacement	6-3
6.3	PID Sensor Cleaning / Replacement	6-6



## TABLE OF CONTENTS

---

6.4 Taking Care of the Lamp	6-8
6.5 Sampling Pump Replacement	6-9
<b>7. Maintenance Of AreaRAE Steel &amp; AreaRAE Gamma Steel</b>	<b>7-1</b>
7.1 Opening the Monitor	7-2
7.2 Reassembling the Monitor	7-2
7.3 Battery Replacement	7-4
7.4 Sensor Replacement	7-5
7.5 PID Sensor Cleaning/Replacement	7-9
7.6 Taking Care of the Lamp	7-10
7.7 Sampling Pump Replacement	7-11
<b>8. Troubleshooting</b>	<b>7-1</b>
8.1 Possible Problems and Solutions	7-2
8.2 Lamp Troubleshooting Details	7-4
8.3 Radio Communication Guide	7-5
<b>9. Contact Information</b>	<b>8-1</b>

### **Acronyms used throughout manual:**

<b>LCD</b>	- Liquid Crystal Display
<b>LED</b>	- Light Emitting Diode
<b>LEL</b>	- Lower Explosive Limit
<b>PC</b>	- Personal Computer
<b>PCB</b>	- Printed Circuit Board
<b>PID</b>	- Photoionization Detector
<b>ppm</b>	- Parts Per Million
<b>RF</b>	- Radio Frequency
<b>STEL</b>	- Short Term Exposure Limit
<b>TWA</b>	- Time Weighted Average
<b>VOC</b>	- Volatile Organic Compound

## INDEX OF TABLES AND FIGURES

---

<b>Table #</b>	<b>Title</b>	<b>Page</b>
1.1	Range, Resolution & Response Time	1-4
2.1	Key Functions During Normal Operation	2-8
2.2	Alarm Signal Summary	2-16
2.3	Alarm Limits and Calibration	2-18
4.1	Programming Keys	4-4

<b>Figure #</b>	<b>Title</b>	<b>Page</b>
2-1	Front View of AreaRAE	2-2
2-2	Right Side View of AreaRAE	2-3
2-3	Left Side View of AreaRAE	2-4
2-4	Front of AreaRAE Steel	2-5
2-5	Right Side View of AreaRAE Steel	2-6
2-6	Left Side View of AreaRAE Steel	2-7
2-7	Display and Keypad	2-8
3-1	Interchangeable Battery Packs (AreaRAE & AreaRAE Gamma)	3-3
3-1	Interchangeable Battery Packs (AreaRAE Steel & AreaRAE Gamma Steel)	3-5
5-1	Block Diagram	5-1
6-1	Internal Components of AreaRAE	6-1
6-2	Gas Plate of AreaRAE	6-4
6-3	Detailed Sensor Assembly of AreaRAE Steel	6-4
7-1	Internal Components of AreaRAE Steel	7-1
7-2	Housing Hex Screw	7-5
7-3	Battery Connection	7-6
7-4	Gas Piping Plate Removal	7-6
7-5	Sensor Locations	7-7
7-6	Sampling Pump On Gas Plate	7-11
7-7	Gas Plate Connector	7-11
7-8	Gas Plate Screw	7-12

# 1. General Information

The AreaRAE is a portable multi-gas monitor that provides real-time measurements and activates alarm signals when exposure exceeds preset limits. The programmable monitor contains up to five sensors that monitor toxic gases, oxygen, combustible gases, and radiation (Gamma models only) for workers in hazardous environments. Depending on the type of sensor installed, the AreaRAE is capable of monitoring:

- **Volatile Organic Compounds**  
PID Sensor using 10.6 eV UV lamp
- **Inorganic Compounds**  
Substance Specific Electrochemical Sensor(s)
- **Combustible Gases**  
0 to 100% LEL range with a catalytic bead sensor
- **Oxygen Concentrations**  
Electrochemical Sensor
- **Gamma Radiation (Gamma models only)**  
Scintillation Crystal Detector

The AreaRAE and AreaRAE Steel consists of:

- The AreaRAE or AreaRAE Steel monitor
- Up to five sensors
- Carbon filters, for monitors equipped with a CO sensor
- Calibration adapter
- Operation and Maintenance manual
- Rechargeable Lithium-Ion battery pack
- Charger
- Spare alkaline battery pack
- Spare external filter
- 76mm (3") inlet probe
- Hard transport case with pre-cut foam
- 5 meters (15') of Teflon<sup>®</sup> tubing
- Tool kit

## **IMPORTANT!**

The central design of all AreaRAE monitors is similar. Therefore, throughout this this Operation & Maintenance Manual, most functions and descriptions are given for the AreaRAE, meaning AreaRAE, AreaRAE Gamma, AreaRAE Steel, and AreaRAE Gamma Steel. Where variations occur, they are noted. These include the gamma radiation sensor in the AreaRAE Gamma and AreaRAE Gamma Steel, and differences between the battery, opening/closing procedure, and sensor and pump replacement in the AreaRAE (black-body) and AreaRAE Steel (stainless steel body) models.

All models are subject to variations in operational radio frequency, owing to regulations in various regions of the world. Although radio communication varies, functions and displays are unaffected.

## 1.1 AreaRAE & AreaRAE Gamma General Specifications

**Table 1.1 Multi-Gas Radiation Monitor Specification**

<b>Dimensions</b>	23.5cm L x 12.7cm W x 23.5cm H (9.25" L x 5.0" W x 9.25" H)
<b>Weight</b>	4.03 kg (8.9 lbs) with battery
<b>Detector</b>	Up to five sensors: <ul style="list-style-type: none"> <li>• PID sensor</li> <li>• LEL sensor</li> <li>• Electrochemical sensors (2 in AreaRAE, 1 in AreaRAE Gamma)</li> <li>• Radiation Sensor (AreaRAE Gamma only)</li> </ul>
<b>Battery</b>	Rechargeable, 7.4V/4.5 Ah, Lithium-Ion battery pack with built-in charger (less than 10 hours charge time) Six C-cell alkaline battery pack
<b>Operating Time</b>	Up to 24 hours of continuous operation. Up to 36 hours of continuous operation with RF disabled.
<b>Display</b>	Two-line, 16-character LCD with manual LED backlight
<b>Keypad</b>	<ul style="list-style-type: none"> <li>• [MODE] – operation &amp; programming</li> <li>• [Y/+] – operation &amp; programming key</li> <li>• [N/-] – operation &amp; programming key</li> <li>• [RADIO] – RF Data Transmission</li> <li>• [VOICE] – not used</li> <li>• [UP/DOWN] – not used</li> </ul>
<b>Direct Readout</b>	<ul style="list-style-type: none"> <li>• Up to five instantaneous values</li> <li>• Sensor name</li> <li>• High and low alarm limits for all sensors</li> <li>• TWA &amp; STEL values for toxic &amp; VOCs</li> <li>• Gamma values (AreaRAE Gamma)</li> <li>• Battery voltage</li> <li>• Elapsed time</li> </ul>

## GENERAL INFORMATION

---

<b>Alarm Settings</b>	Separate alarm limit settings for TWA, STEL, Low and High alarm
<b>Visible Alarm</b>	100dB buzzer at 10 cm (typical)
<b>Audible Alarm</b>	Flashing red LED cluster to indicate exceeded preset limits, low battery, or sensor failure
<b>Calibration</b>	Two point field calibration for fresh air and standard reference gas
<b>Attachments</b>	Optional tripod/wall mounting bracket
<b>Sampling Pump</b>	Internal integrated diaphragm pump with programmable “High” (400 cc) and “Low” (300 cc) flow rate settings
<b>Protection</b>	Password protected calibration settings, alarm limits, and data
<b>EM Immunity</b>	No effect when exposed to 0.43 mW/cm <sup>2</sup> RF interference (5 watt transmitter at 12”); Caution: Excessive EMI may cause incorrect operation
<b>Data Storage</b>	20,000 readings (64 hours, 5 channels at 1-minute intervals) in non-volatile memory
<b>Datalog Interval</b>	Programmable 1 to 3600 seconds
<b>Communication</b>	Upload data to PC and download monitor setup from PC through RS-232 link to serial port on PC
<b>Temperature</b>	-20° C to 45° C (-4° F to 113° F)
<b>Humidity</b>	0% to 95% relative humidity (Non-condensing)
<b>Warm-up Time</b>	90 seconds
<b>Environmental Pressure</b>	1.0 ATM ±10%
<b>Configuration</b>	2, 3, and 4 gas (plus gamma radiation in AreaRAE Gamma), with pump, equipped with or without datalogging
<b>Wireless Feature</b>	Real-time, RF data transmission
<b>Safety Certification</b>	CSA Canada/USA Class I, Division 2 Groups A, B, C, D <b>AreaRAE only:</b> UL USA Class I, Division 2 Groups A, B, C, D; Class II, Groups E, F, G

---

GENERAL INFORMATION

---

**Table 1.2** Range, Resolution & Response Time ( $T_{90}$ )

<b>CO</b>	0 to 500 ppm	1 ppm	40 sec
<b>H<sub>2</sub>S</b>	0 to 100 ppm	1 ppm	35 sec
<b>SO<sub>2</sub></b>	0 to 20 ppm	0.1 ppm	35 sec
<b>NO</b>	0 to 250 ppm	1 ppm	30 sec
<b>NO<sub>2</sub></b>	0 to 20 ppm	0.1 ppm	25 sec
<b>Cl<sub>2</sub></b>	0 to 10 ppm	0.1 ppm	60 sec
<b>O<sub>2</sub></b>	0 to 30%	0.1%	15 sec
<b>VOC</b>	0 to 200 ppm	0.1 ppm	10 sec
<b>VOC</b>	200 to 2000 ppm	1 ppm	10 sec
<b>LEL</b>	0 to 100 %	1%	15 sec
<b>HCN</b>	0 to 100 ppm	1 ppm	200 sec
<b>NH<sub>3</sub></b>	0 to 50 ppm	1 ppm	120 sec
<b>PH<sub>3</sub></b>	0 to 5 ppm	0.1 ppm	60 sec
<b>Gamma</b>	1 to 4000 $\mu$ R/hr	1 $\mu$ R/hr	10 sec

**Caution:**

Refer to RAE Systems Technical Note TN-114 for sensor cross-sensitivities.

Refer to RAE Systems Technical Note TN-144 for information on LEL sensor poisoning.

## 1.2 AreaRAE Steel & AreaRAE Gamma Steel General Specifications

**Table 1.3 Multi-Gas Monitor Specifications**

<b>Dimensions</b>	23.5cm L x 12.7cm x 23.5cm (9.25" L x 5.0" W x 9.25" H)
<b>Weight</b>	6.48 kg (14.3 lbs) with battery
<b>Detector</b>	Up to five sensors: <ul style="list-style-type: none"> <li>• PID sensor</li> <li>• LEL sensor</li> <li>• Electrochemical sensors (3)</li> </ul>
<b>Battery</b>	Rechargeable, 7.4V/4.5 Ah, Lithium-Ion battery pack with built-in charger (less than 10 hours charge time) Six C-cell alkaline battery pack
<b>Operating Time</b>	Up to 24 hours of continuous operation. Up to 36 hours of continuous operation with RF disabled.
<b>Display</b>	Two-line, 16-character LCD with manual LED backlight
<b>Keypad</b>	<ul style="list-style-type: none"> <li>• [MODE] – operation &amp; programming</li> <li>• [Y/+] – operation &amp; programming key</li> <li>• [N/-] – operation &amp; programming key</li> <li>• [RADIO] – RF Data Transmission</li> <li>• [VOICE] – not used</li> <li>• [UP/DOWN] – not used</li> </ul>
<b>Direct Readout</b>	<ul style="list-style-type: none"> <li>• Up to five instantaneous values</li> <li>• Sensor name</li> <li>• High and low alarm limits for all sensors</li> <li>• TWA &amp; STEL values for toxic &amp; VOCs</li> <li>• Battery voltage</li> <li>• Elapsed time</li> </ul>
<b>Alarm Settings</b>	Separate alarm limit settings for TWA, STEL, Low and High alarm



## GENERAL INFORMATION

---

<b>Audible Alarm</b>	100dB buzzer at 10 cm (typical)
<b>Visible Alarm</b>	Flashing red LED cluster to indicate exceeded preset limits, low battery, or sensor failure
<b>Calibration</b>	Two point field calibration for fresh air and standard reference gas
<b>Attachments</b>	Optional tripod/wall mounting bracket
<b>Sampling Pump</b>	Internal integrated diaphragm pump with programmable "High" (400 cc) and "Low" (300 cc) flow rate settings
<b>Protection</b>	Password protected calibration settings, alarm limits, and data
<b>Safety</b>	CSA Canada/USA Class I, Division 2 Groups A, B, C, D; EX II 3G EEx nAL IIC T6
<b>EM Immunity</b>	No effect when exposed to 0.43 mW/cm <sup>2</sup> RF interference (5-watt transmitter at 305 mm/12")
<b>Data Storage</b>	20,000 readings (64 hours, 5 channels, at 1-minute intervals) in non-volatile memory
<b>Datalog Interval</b>	Programmable 1 to 3600 seconds
<b>External Alarm</b>	Optional plug-in pen size vibration alarm or earphone
<b>Communication</b>	Upload data to PC and download monitor setup from PC through RS-232 link to serial port on PC
<b>Temperature</b>	-20° C to 45° C (-4° F to 113° F)
<b>Humidity</b>	0% to 95% relative humidity (Non-condensing)
<b>Configuration</b>	2, 3, 4 and 5 gas with pump, equipped with or without datalogging

---

GENERAL INFORMATION

---

**Table 1.4** Range, Resolution & Response Time ( $T_{90}$ )

<b>CO</b>	0 to 500 ppm	1 ppm	40 sec
<b>H<sub>2</sub>S</b>	0 to 100 ppm	1 ppm	35 sec
<b>SO<sub>2</sub></b>	0 to 20 ppm	0.1 ppm	35 sec
<b>NO</b>	0 to 250 ppm	1 ppm	30 sec
<b>NO<sub>2</sub></b>	0 to 20 ppm	0.1 ppm	25 sec
<b>Cl<sub>2</sub></b>	0 to 10 ppm	0.1 ppm	60 sec
<b>O<sub>2</sub></b>	0 to 30%	0.1%	15 sec
<b>VOC</b>	0 to 200 ppm	0.1 ppm	10 sec
<b>VOC</b>	200 to 2000 ppm	1 ppm	10 sec
<b>LEL</b>	0 to 100%	1%	15 sec
<b>HCN</b>	0 to 100 ppm	1 ppm	200 sec
<b>NH<sub>3</sub></b>	0 to 50 ppm	1 ppm	120 sec
<b>PH<sub>3</sub></b>	0 to 5 ppm	0.1 ppm	60 sec

## 1.3 AreaRAE Steel Radio Technical Specifications (869MHz Versions)

<b>Radio Characteristics</b>	
<b>RF Frequency</b>	869.400 to 869.650MHz, 2 user-selectable channels
<b>Number of Channel</b>	2 (Ch. 1: 869.50MHz; Ch. 2: 869.560MHz)
<b>Channel Spacing</b>	60kHz
<b>RF Data rate</b>	38.4kbps
<b>Modulation</b>	GFSK
<b>Duplex</b>	TDD
<b>Maximum E.R.P.</b>	500 mW (27 dBm)
<b>Receiver Sensitivity</b>	-106 dBm at $10^{-3}$ BER
<b>Receiver Classification</b>	Class 2
<b>Operating Range</b>	Up to 3.2 km (2 miles) in line of sight
<b>Network Protocol</b>	Purpletooth™ Adaptive Intelli-Polling
<b>Operating Mode</b>	Master, Slave. Mesh network
<b>Error Detection</b>	CRC and ARQ
<b>Radio Type Approval Certificate</b>	CE: comply with EN300 220-1, 2000; EN300 220-3, 2000; EN301 489-1, 2004; EN300 489-3, 2002.
<b>I/O Interface</b>	RS-232, RS485
<b>Antenna Port Interface</b>	MCX female
<b>Power Supply</b>	6V to 18V
<b>Power Consumption</b>	Tx: 300mA @ 7.4V Rx: 45mA @ 7.4V Idle: 30mA @ 7.4V

## 1.4 AreaRAE & AreaRAE Steel Radio Technical Specifications (900MHz Versions)

<b>Radio Characteristics</b>	
<b>RF Frequency</b>	902 to 928MHz
<b>Method</b>	Frequency hopping spread spectrum
<b>Hopping Channels</b>	105 total, user selectable
<b>Hopping Bands</b>	7 user selectable
<b>Operating Range</b>	Up to 3.2 km (2 miles) in line of sight
<b>Occupied Bandwidth</b>	26 MHz
<b>Modulation</b>	GFSK, 144 to 188 kbps
<b>RF Connector</b>	N female
<b>System Gain</b>	140dB
<b>Transmitter Output</b>	100mW to 1 Watt (+30dB)
<b>Receiver Sensitivity</b>	-108 dBm at $10^{-6}$ BER -110 dBm at $10^{-4}$ BER
<b>Error Detection</b>	32-bit CRC, retransmit on error
<b>Data Encryption</b>	Substitution, dynamic key
<b>Link Throughput</b>	115.2 kbps standard speed
<b>I/O Interface</b>	RS-232, RS-485, RS-422
<b>Power Requirements</b>	6V to 30V
<b>Power Consumption</b>	Tx: 1000mA @ 6V Rx: 152mA @ 6V Idle: 40mA @ 6V Sleep: 8mA @ 6V

## 1.5 AreaRAE & AreaRAE Steel Radio Technical Specifications (2.4GHz Versions)

<b>Radio Characteristics</b>	
<b>RF Frequency</b>	2.400 to 2.4835 GHz, 3 user-selectable channels
<b>Spread Spectrum</b>	Direct Sequence (DSSS)
<b>Processing Gain</b>	11.2 to 17.4dB
<b>Operating Range</b>	Greater than 1.6km (1 mile)
<b>Receiver Sensitivity</b>	-93 dBm at $10^{-6}$ BER with 1Mbps
<b>Maximum EIRP</b>	100mW to 1 Watt (+30dBm)
<b>Channel Bandwidth</b>	32 MHz max.
<b>Operating Mode</b>	Master, Slave. Mesh network
<b>Communication Method</b>	Time Division Duplex (TDD)
<b>Error Detection</b>	CRC and ARQ
<b>Baseband Modulation</b>	BPSK and QPSK
<b>Channel Data Rate</b>	256 kbps, 512 kbps, 1 Mbps
<b>Mobility</b>	Throughput >115.2 kbps at relative speed 100 km/hr (60 miles/hr)
<b>I/O Interface</b>	RS-232
<b>Antenna Port Interface</b>	N female
<b>Power Supply</b>	12V
<b>Current Consumption</b>	Tx: 535mA @ 7.4V Rx: 310mA @ 7.4V Idle: 85mA @ 7.4V

## 2. Operation

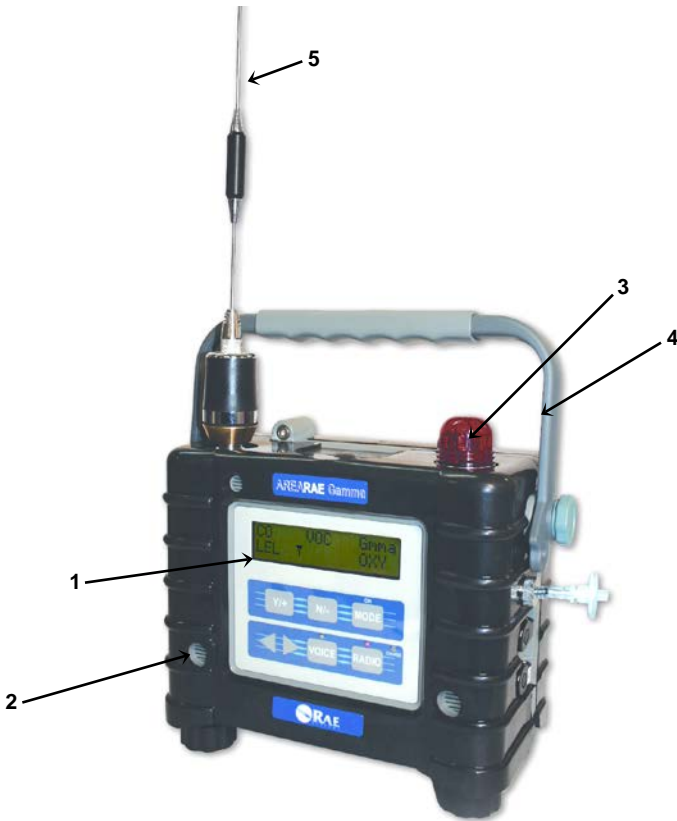
The AreaRAE Multi-Gas Monitor is a compact, portable instrument that provides real-time measurements and activates alarm signals when exposure exceeds preset limits. Prior to factory shipment, the AreaRAE is preset with default alarm limits, and sensors are pre-calibrated with standard calibration gas. However, the user should calibrate the instrument before first use. After the monitor is fully charged and calibrated, it is ready for immediate operation.

### **NOTE**

Refer to ANSI/ISA RP12.13.02 for general information on installation, operation, and maintenance of combustible gas detection instruments.

## 2.1 Physical Description

### 2.1.1 AreaRAE & AreaRAE Gamma



**Figure 2-1** Front View: Main Components

1. LCD Display with Backlight
2. Audible Alarm Port
3. Red LED Alarm Light
4. Handle
5. Antenna

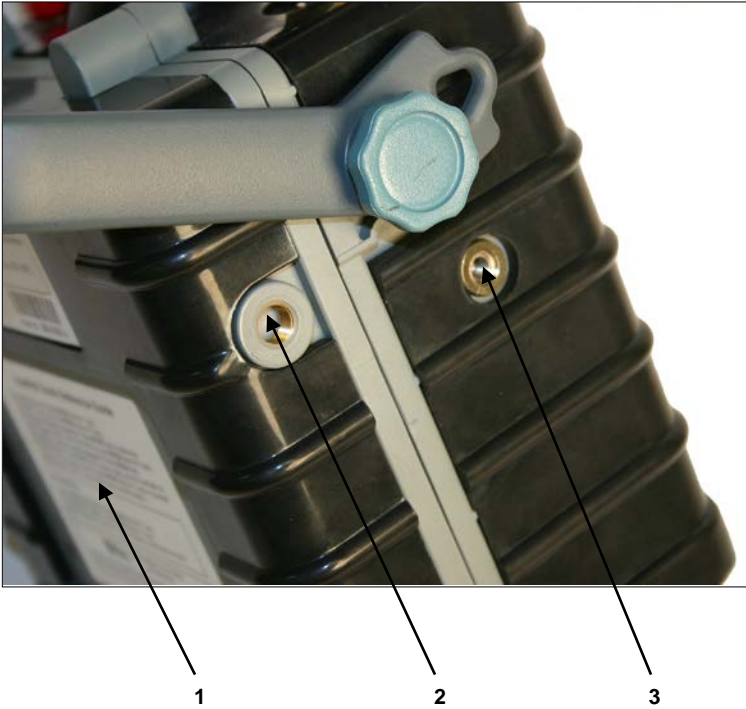
## OPERATION OF THE AREARAE



**Figure 2-2** Right Side View: Main Components

1. Gas inlet port
2. Serial communication port for PC interface
3. Charger port: power jack connects AreaRAE to external DC for charging
4. External Filter

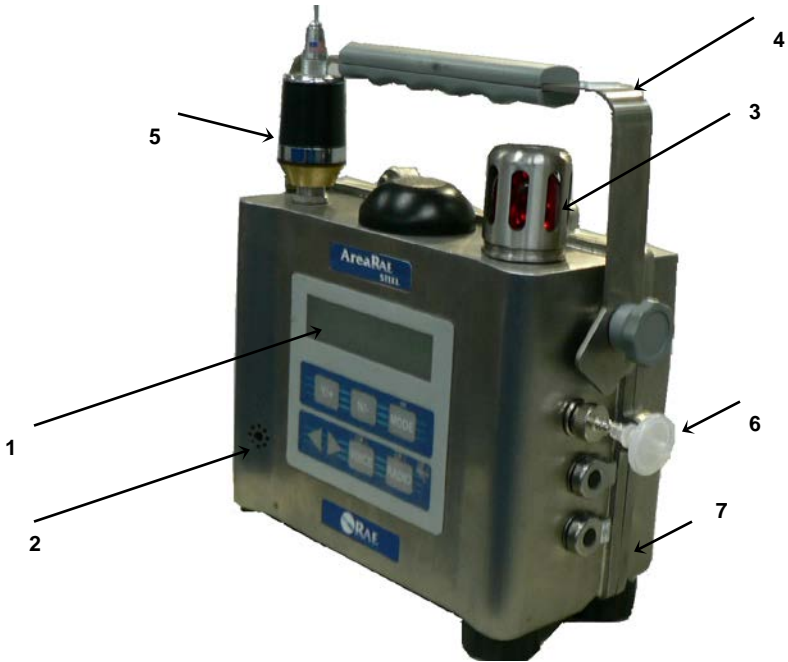




**Figure 2-3** Left Side View: Main Components

1. Battery Pack
2. Gas outlet
3. Mounting conduit

## 2.1.2 AreaRAE Steel & AreaRAE Gamma Steel



**Figure 2-4** Front View of the AreaRAE Steel

1. LCD Display with Backlight
2. Audible Alarm Port
3. Red LED Alarm Light
4. Handle
5. Antenna
6. Inlet filter
7. Stainless steel enclosure



**Figure 2-5** Right side of the AreaRAE Steel

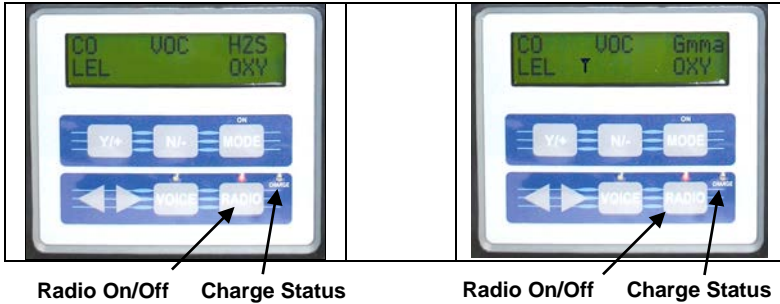
1. Gas inlet port
2. Serial communication port for PC interface
3. Charger port: power jack connects the AreaRAE Steel to external DC for charging
4. External filter



**Figure 2-5** Left side of the AreaRAE Steel

1. Battery compartment: AreaRAE Steel monitors are equipped with interchangeable rechargeable Lithium-Ion and alkaline battery packs
2. Gas exit port

## 2.2 Keys and Display



**Figure 2-6** AreaRAE and AreaRAE Steel (left) and AreaRAE Gamma and AreaRAE Gamma Steel Display and Keypad (right)

Key	Function
<b>[MODE]</b>	Turn power on/off Choose different display mode
<b>[N/-]</b>	Toggle backlight on/off Answer “No” Decrease values
<b>[Y/+]</b>	Alarm test and alarm acknowledgment Turn latched alarm off Turn pump or LEL sensor on Answer “Yes” Increase values
<b>[RADIO]</b>	Radio Frequency Data Transmission on/off
<b>[VOICE]</b>	not used
<b>Left/Right arrows</b>	not used

## 2.3 Turn Power On/Off

### To turn ON

Press [MODE]. The audio buzzer beeps once, and the screen displays the following, in order:

- “ON!”
- “Multi-gas Monitor Version n.nn” or “Multi-gas Radiation Monitor Version n.nn” (the software version)
- Custom power-on-name, which can be changed by using the ProRAE Suite Software
- Model number, serial number, current date and time, and temperature
- Each sensor socket to check if a valid sensor is installed. If a new sensor is installed, a message to remind the user to calibrate the sensor will be displayed followed by a message that the alarm limits have been reset to the default values for the new sensor.
- Warranty expiration date for each sensor
- Preset alarm limits for each sensor
- Last calibration date
- Battery voltage
- Shut off voltage
- User mode
- Alarm mode
- Available data storage memory (in hours)
- Datalog mode
- Datalog period
- Fresh air calibration if Power On Zero is enabled
- Instantaneous reading of the gas concentration in ppm

### To turn OFF

Press and hold [MODE] for 5 seconds. The monitor beeps once every second during the power-down sequence. A countdown timer shows the remaining seconds. After that, the screen flashes “Off!” and then goes blank, indicating the monitor is off.

## 2.4 Data Protection

When the monitor is turned off, all the current real-time data including TWA, STEL, Peak and elapsed time are erased. However, the datalog data is preserved in non-volatile memory. Even if the battery is disconnected, the datalog data will not be lost. When the monitor is off, the real-time clock will continue to operate until the battery is completely drained (usually in 5 to 7 days without any charging).

If the battery is completely drained or is disconnected from the monitor for more than 30 minutes, the real-time clock will be lost. In this case, the user needs to enter the real-time clock information again, as described in Section 4.7.5.

### **Datalog-enabled monitor versus non-datalog monitor**

The AreaRAE is available with datalogging and without datalogging. A Datalog monitor allows storing the gas concentration readings (see Section 2.10: Datalogging Operations).

During the power on sequence, a letter “D” following the version number indicates that the monitor is configured as a datalog-enabled monitor. The absence of a letter “D” indicates a non-datalog monitor.

You may upgrade a non-datalog monitor to a datalog monitor. Call RAE Systems for information on how to order the upgrade kit.

## 2.5 Operation Modes

The AreaRAE offers three different modes of operation:

- **Text Mode**
- **Display Mode**
- **Program Mode**

The default mode is Text Mode. To enter the other two modes, or to enter Text Mode again after another mode has been selected, follow this procedure:

1. Press [N/-] and [MODE] simultaneously.
2. Enter a password (the factory default value is "0000").  
Press [Y/+] to decrease a number.  
Press [N/-] to increase a number.  
Press [MODE] to step to the next digit.
3. Hold [MODE] for 1 second to enter the password.
4. Scroll through the options by pressing [N/-].
5. At "Change Monitor Setup," press [Y/+].
6. Scroll through the options by using [N/-].
7. When you see "Change User Mode?" press [Y/+].
8. Choose Display, Text, or Program by pressing [N/-].
9. Choose the selection by pressing [Y/+].
10. Confirm your selection by pressing [Y/+] again.

To return to the screen with readings, press [MODE] twice.

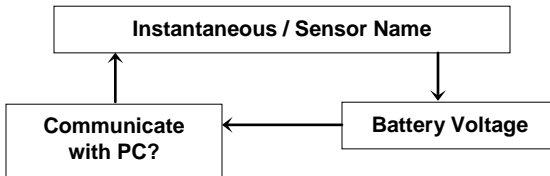


## 2.5.1 Text Mode

Text Mode is the monitor's default setting. The monitor toggles between the Instantaneous Gas Concentration reading and the Sensor Name after the monitor is turned on. You can press [MODE] to see the Instantaneous Gas Concentration reading or Battery Voltage, or you may enter the PC Communication menu. You may enter Calibration Mode from Text Mode to perform calibrations, but not change the parameters.

### Displays

The four displays are arranged in a repeating cyclical sequence:



## 2.5.2 Display Mode

The Display Mode includes all the information from Text Mode in addition to the options listed below. See Section 4.3 Entering Programming Mode for details. To access each display, press [MODE] once.

1. The **instantaneous reading** is the actual gas concentration in parts per million (ppm) for toxic or VOC gases, percent of volume for oxygen, and percent LEL for combustible gases. On Gamma models the reading is in micro sieverts per hour or micro rems per hour. Readings are updated every second.

TOX1	VOC	TOX2	TOX1	VOC	Gamma
0	0.0	0	0	0.0	0
LEL	STEL	19.9	LEL	STEL	19.9
LEL		OXY	LEL		OXY
<b>AreaRAE</b>			<b>AreaRAE Gamma</b>		

### AreaRAE and AreaRAE Steel (non-Gamma models) only:

2. The **sensor names** display (non-Gamma monitors only):  
 CO, H2S, etc. - up to two toxic sensors  
 VOC - PID sensor  
 LEL - combustible gas sensor  
 OXY - oxygen sensor  
 Gamma – gamma radiation sensor (Gamma models only)

TOX1	VOC	TOX2	TOX1	VOC	Gamma
CO	VOC	H2S	CO	VOC	Gamma
LEL		OXY	LEL		OXY
LEL		OXY	LEL		OXY
<b>AreaRAE</b>			<b>AreaRAE Gamma</b>		

### AreaRAE Gamma and AreaRAE Gamma Steel only:

- 2a. The **unit display** shows the measurement unit for each sensor. The toxic and PID sensors are measured in parts-per-million (ppm). The oxygen and LEL sensors are measured by percentage (%). The gamma radiation sensor

## OPERATION OF THE AREARAE

---

is measured in micro sieverts per hour ( $\mu\text{Sv/hr}$ ) or micro rems-per-hour ( $\mu\text{R/hr}$ ).

TOX1	VOC	Gamma
ppm	ppm	$\mu\text{R/hr}$
%		%
LEL		OXY

- 2b. The **accumulated dosage display** shows the total radiation dosage since the last reset. Press [Y/+] to clear the dosage reading.

TOX1	VOC	Gamma
Accumulated Dose = 1.00 $\mu\text{Rem}$		
LEL		OXY

3. The **peak reading** is the highest reading of each gas concentration since the monitor was turned on. Readings are updated every second with a "Peak" message:

TOX1	VOC	TOX2
5	2.0	3
10	Peak	20.9
LEL		OXY

**AreaRAE**

TOX1	VOC	Gamma
CO	VOC	Gamma
LEL		OXY

**AreaRAE Gamma**

## OPERATION OF THE AREARAE

---

The **minimum reading** is the lowest reading of each gas concentration since the monitor was turned on. Readings are updated every second with a “Min” message:

TOX1	VOC	TOX2
0	0.0	0
0	Min	19.9

LEL OXY

**AreaRAE**

TOX1	VOC	Gamma
0	0.0	0
0	Min	19.9

LEL OXY

**AreaRAE Gamma**

4. The **STEL reading** only applies to VOC and toxic gases. It is the last 15-minute average gas concentration reading, which is updated in every minute and is indicated by a “STEL” message:

**Note:** “\*\*\*\*” is displayed in the first 15 minutes.

TOX1	VOC	TOX2
****	****	****
STEL		

LEL OXY

**AreaRAE**

TOX1	VOC	Gamma
****	****	
STEL		

LEL OXY

**AreaRAE Gamma**

5. The **TWA reading** only applies to VOC and toxic gases. The reading is the accumulated reading of the gas concentration divided by 8 hours since the monitor was turned on. The reading is updated every minute and is indicated by the “TWA” message:

TOX1	VOC	TOX2
0	0.0	0
TWA		

LEL OXY

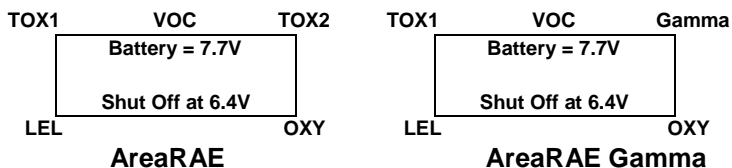
**AreaRAE**

TOX1	VOC	Gamma
0	0.0	
TWA		

LEL OXY

**AreaRAE Gamma**

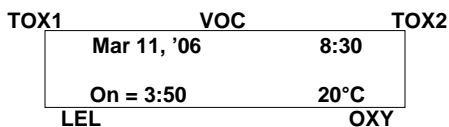
6. The **battery voltage** is the current battery voltage (V) reading. The reading is updated every second and is shown with the shutoff voltage:



**Note:** A fully charged battery pack should show 7.7 volts or higher. When the battery voltage falls below 6.6 volts, a flashing “Bat” warning message appears. This means that there is approximately 20 to 30 minutes of operating time remaining before the battery voltage falls below 6.4 V and the monitor automatically turns off.

**7 through 9 apply to AreaRAE and AreaRAE Steel (non-Gamma models) only:**

7. The **run time reading** is the accumulated time in hours and minutes the monitor has been on. The reading is updated in every minute and is displayed with the current date, time and temperature:



8. The **datalog menu** shows the current datalog mode. If the manual datalog mode is selected, the menu prompts you to turn datalogging on or off. When “Start Datalog?” displays, press [Y/+] to turn datalogging on. Likewise, when “Stop Datalog?” displays, press [Y/+] to turn it off.
9. The monitor displays the selected **LEL** and **VOC gas name** if the combustible sensor and PID sensor are installed. When an LEL or VOC gas is selected, the display features the calculated gas concentration based on the built-in correction factor for the specified gas.

## OPERATION OF THE AREARAE

---

10. “**Communicate with PC?**” allows you to upload data from the AreaRAE to a PC or to download configuration information from a PC to the AreaRAE.

Press [Y/+] and the message “Monitor will pause, OK?” reminds you that during PC communication, there is no real-time monitoring.

Press [Y/+] to proceed and the monitor enters communication standby mode\*. The “Ready...” display appears on the top line of the LCD and the “Turn radio off!!” message appears on the second line.

**Note:** It is important to turn off the Radio button before attempting to communicate with the PC.

Connect the monitor to the serial port on a PC. The monitor is ready to receive any command from the PC.

Press [MODE] again to return to the first display.

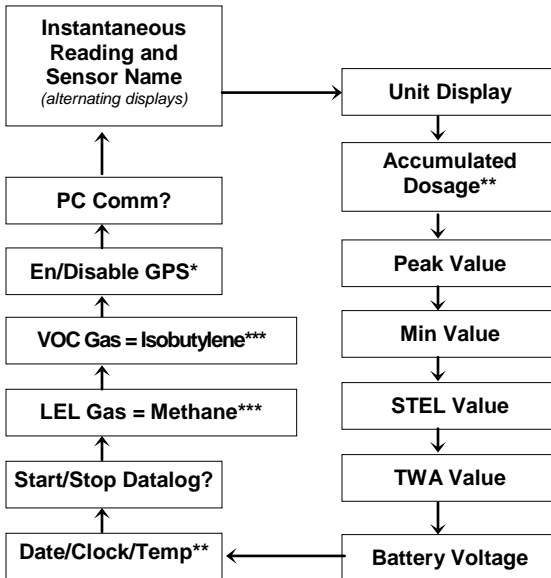
**\*Note:** When the monitor is in communication standby mode, it stops monitoring the gas concentration and stops datalogging. Datalogging must be manually restarted when exiting communication standby mode, when it is in manual start/stop mode.

## 2.5.3 Program Mode

The user may perform all Display Mode functions. See Section 4.3 Entering Programming Mode for details.

### Displays

The functions are arranged in a repeating, cyclical sequence:



\* If the unit is GPS-capable

\*\* If the unit is a Gamma model

\*\*\* The following displays are only available in Program Mode on AreaRAE Gamma and AreaRAE Gamma Steel:

1. The **run time reading** is the accumulated time in hours and minutes the monitor has been on. The reading is updated every minute and is displayed with the current date, time and temperature:

TOX1	VOC	Gamma
	Mar 11, '06	8:30
	On = 3:50	20°C
LEL		OXY

2. The monitor displays the selected **LEL** and **VOC gas name** if the combustible sensor and PID sensor are installed. When an LEL or VOC gas is selected, the display features the calculated gas concentration based on the built-in correction factor for the specified gas.



## 2.6 Alarm Signals

The built-in microprocessor continually updates and monitors gas concentration levels. It also compares the readings with programmed TWA, STEL, Low, and High instantaneous gas concentration alarm limit settings. Whenever the concentration exceeds any of the preset limits, the buzzer and red LED immediately warns you of the alarm condition. Additionally, the AreaRAE alarms if one of the following conditions occurs:

- Battery voltage falls below a preset voltage level (6.6V)
- Failure of 10.6 eV UV lamp
- LEL sensor is off
- Pump stalls
- Datalog memory is full

When the low battery alarm occurs, there is approximately 20 to 30 minutes of operating time remaining before the battery voltage falls below 6.4 V and the monitor automatically turns off.

### Alarm Signal Disabled

It is extremely important to note that the alarm signals are disabled during the following conditions:

- PC communication standby mode
- Calibration mode

During these modes of operation, real-time monitoring gas concentration stops. None of the gas concentrations is calculated, including Peak, STEL and TWA values.

### Alarm Signal Latching

It is possible to set up the AreaRAE from a PC or while the unit is in Program Mode so that when an alarm condition occurs, the alarm signals remain on even after the alarm condition is no longer present. This is called the "latching alarm" mode. The alternative mode is to automatically reset the alarm signal once the alarm condition is clear. The default alarm mode is automatically reset. (See Section 4.7.3: Change Alarm Mode.)

## OPERATION OF THE AREARAE

<b>Table 2.2 Alarm Signal Summary</b>		
<b>Condition</b>	<b>Alarm Signal</b>	<b>Message on LCD Screen</b>
Gas or Gamma* exceeds "High Alarm" limit	3 beeps & flashes per second	Sensor Name
Gas or Gamma* exceeds "Low Alarm" limit	2 beeps & flashes per second	Sensor Name
Gas exceeds STEL	1 beep & flash per second	Sensor Name
Gas exceeds TWA	1 beep & flash per second	Sensor Name
Negative Drift or Over Range	3 beeps & flashes per second	"NEG" or "OVR"
Pump failure	3 beeps & flash per second	"Pump"
LEL sensor off	3 beeps & flash per second	LEL Sensor name and "Off"
PID lamp failure	3 beeps & flashes per second	"Lamp"
Low battery	1 beep & flash per minute	"Bat"
Memory full	1 beep & flash per minute	"Mem"

\* AreaRAE Gamma and AreaRAE Steel only.

### **Alarm Signal Testing**

Under normal conditions, it is possible to test the AreaRAE LED, buzzer, and back light by momentarily pressing [Y/+]. The buzzer beeps once, and the LED and backlight flash once to indicate alarm signals are functioning correctly.



Because alarm signals are disabled during PC Communication and Calibration modes, it is highly recommended to use calibration mode only in areas known to be non-hazardous, in order to reduce the risk of exposure to hazardous atmospheres. PC communication must be used only in non-hazardous locations.

## 2.7 Backlight

The LCD is equipped with a backlight to assist reading under poor lighting conditions. When the monitor is in Normal Operation mode, the backlight may be manually turned on by pressing and holding [N/-] for one second. Press [N/-] a second time to turn off. If [N/-] is not pressed, the back light will automatically turn off after preset time-out period (set by ProRAE Suite) to save power. The back light automatically activates during alarm conditions.

**Note:** The LED backlight consumes a higher amount of energy from the battery and shortens the operating time of the monitor by 20% to 30%.

## 2.8 Alarm Limits & Calibration

The AreaRAE is factory calibrated with standard calibration gas, and is programmed with default alarm limits as listed below. (See Section 4.4: Calibration of the AreaRAE Steel and Section 4.5: Change Alarm Limits)

<b>Table 2.3 AreaRAE Alarm Limits &amp; Calibration</b>						
Gas ppm	Cal Gas / Balance	Unit	TWA	STEL	Low	High
CO	50 / Air	ppm	35	100	35	200
H <sub>2</sub> S	10 / N <sub>2</sub>	ppm	10	15	10	20
SO <sub>2</sub>	5 / N <sub>2</sub>	ppm	2	5	2	10
NO	25 / N <sub>2</sub>	ppm	25	25	25	50
NO <sub>2</sub>	5 / Air	ppm	1	1	1	10
Cl <sub>2</sub>	10 / N <sub>2</sub>	ppm	0.5	1	0.5	5
O <sub>2</sub>	20.9 / N <sub>2</sub>	%	-	-	19.5	23.5
CH <sub>4</sub>	50 / Air	%LEL	-	-	10	20
HCN	10 / N <sub>2</sub>	ppm	4.7*	4.7*	4.7*	50
NH <sub>3</sub>	50 / N <sub>2</sub>	ppm	25	35	25	50
PH <sub>3</sub>	5 / N <sub>2</sub>	ppm	0.3	1	1	2
VOC**	100 / Air	ppm	10.0	25.0	50.0	100
*The LCD display is truncated to show "4."						
**100 ppm isobutylene gas is used for VOC gas calibration.						

<b>Caution:</b> Refer to RAE Systems Technical Note TN-114 for sensor cross-sensitivities.
--

<b>Table 2.4 AreaRAE Gamma &amp; AreaRAE Gamma Steel Alarm Limits &amp; Calibration</b>			
Radiation Type	Unit	Low	High
Gamma	μRem	100	250
Gamma	μSv	1	25

## 2.9 Integrated Sampling Pump

The AreaRAE includes an internal integrated sampling pump with programmable high (400cc) and low (300cc) flow rate settings.

A low pump speed of ~300cc per minute is the factory default setting. This rate increases battery life by about 5%, which results in an increased LEL sensor lifetime (See Section 4.7.9: Change Pump Speed).

The high pump speed setting is required for vapors that are especially reactive or easily absorbed by instrument surfaces. Such vapors include, but are not limited to: Cl<sub>2</sub>, PH<sub>3</sub>, NH<sub>3</sub>, HCN, and semi-volatile organic compounds like diesel fuel and jet fuels. Here are some suggestions for monitoring such compounds:

- Remove the External Filter for normal calibration and operation, which increases the pump speed to ~300 cc per minute.
- Use inert connecting or sampling tubing, such as Teflon<sup>®</sup> instead of Tygon<sup>®</sup>; make tube connections as short as possible.

The pump automatically turns on when the monitor is turned on. It remains on during normal operation.

If liquid or other substances are sucked into the External Filter through the gas entry port, causing the pump to stall, the electronics of the monitor immediately detect the obstruction and shut down the pump. The alarm activates and you see the flashing "Pump" error message. After the filter is changed or obstacles are removed, press [Y/+] to restart the pump.

## 2.10 Datalogging

The AreaRAE calculates and stores gas readings based on the user-specified datalogging period and type of measurement. Two types of gas measurements, average or peak concentration may be stored for each sensor for any datalogging interval. Datalogging intervals may be programmed from 1 second to 60 minutes in 1-second increments. In addition, time stamp, user ID, site ID, serial number, last calibration date, and alarm limits are also stored. Since all data is retained in non-volatile memory, The user may download information to their PC at a later time.

### Datalog Options

Most of the datalogging options may be programmed from the monitor. When the monitor is connected to a PC, additional options may be programmed and then downloaded to the monitor. There are four options to select from:

1. Automatic: automatically starts and stops datalogging when the monitor is turned on and off, respectively.
2. Manual: You manually start and stop datalogging. You may also set the timer for datalog run times.
3. Periodic: datalogging is scheduled on a daily basis with a preset parameter in hours and minutes.
4. Schedule: datalogging is scheduled for a preset date (month/day) and time (hour/minute).

### Start/Stop Datalogging Manually

1. Press [MODE] to toggle through the normal operation menu until "Start Datalog?" appears.
2. Press [Y/+] to start datalogging.
3. Press [Y/+] again, and "Stop Datalog?" will appear.
4. Press [Y/+] a third time to stop datalogging.

Other Datalog options automatically start and stop:

### **Datalogging Event**

Each time a datalogging operation is initiated, a datalog event is created. Information, such as start time, datalogging period, alarm limits, etc., is recorded in the event header, followed by the measurement data.

### **Datalogging Pause**

Datalogging automatically pauses under the following conditions:

1. **Upon entering Program Mode.** Datalogging resumes upon exiting the Program Mode.
2. **Upon entering PC Communication standby mode.** Datalogging resumes upon exiting PC communication standby mode, if datalogging mode was not set to manual start/stop.

In both cases a new datalog event will be created when the datalogging is resumed.

## 3. Operation of Accessories

The accessories for the AreaRAE include:

- Battery charger
- Alkaline battery adapter
- External Filter and remote sampling probe
- Dilution fitting
- Calibration adapter

### 3.1 Battery Charging Operation

The charging circuit of the AreaRAE is built into the monitor. It requires a regular AC to 15 VDC adapter (a wall-mount transformer) to charge the monitor.

1. Connect the AC adapter (or the optional automotive charging adapter) to the charger port on the bottom of the AreaRAE monitor.
2. An LED labeled "Charge" is located on the front of the instrument. A red light indicates the battery is charging. A green light indicates the battery is fully charged.
3. A completely drained AreaRAE monitor's battery is typically charged to full capacity within 10 hours.

**Note:** The rechargeable Lithium-Ion battery pack slowly drains even when the monitor is off. If the monitor has not been charged for 5 to 7 days, the battery voltage will be low.

The factory-supplied battery is designed for up to 24 hours of normal operation, without alarm conditions or backlight usage. As the battery ages or is subjected to adverse conditions, such as cold ambient temperatures, the battery capacity may be significantly reduced.



 **WARNING** 

To reduce the risk of ignition of hazardous atmospheres, recharge battery only in area known to be non-hazardous. Remove and replace battery only in area known to be non-hazardous.

Ne charger les batteries que dans l'emplacement désigné non dangereux.

Exception: For PGM5x20S, charging battery in a Class I, Division 2 hazardous location is permitted if installation complies with 029-STCM-001. The installation requires:

- Charging circuit to be run within conduit
- AreaRAE to be installed within a larger enclosure that provides conduit entry and requires a tool to open.
- Charging circuit cable must be terminated with a Switchcraft S761K or equivalent (see RAE 400-0472-000 for critical requirements) plug with locking collar.
- The mating charging circuit connectors must be locked together using the threaded collar before the circuit is powered.

## 3.2 Interchangeable Battery Packs

### 3.2.1 AreaRAE

An alkaline battery adapter is supplied with each AreaRAE and AreaRAE Gamma kit. It may be used in place of the rechargeable Lithium-Ion battery pack to provide at least 24 hours of operation.

The alkaline pack holds 6 C-size alkaline batteries. Use only DURACELL MN1400 or ENERGIZER E93 C-size batteries with the AreaRAE and AreaRAE Gamma alkaline battery pack.



**Figure 3-1. Interchangeable Battery Packs**

### Recharging the Lithium-Ion Battery Pack

1. Turn off power of the AreaRAE.
2. Connect the AC adapter (or the optional automotive charging adapter) to the charger connection port on the AreaRAE.
3. A red “charge” LED located on the front of the instrument will indicate that the battery is being charged. A completely drained AreaRAE will be fully charged within 10 hours.

### Removing or Replacing the Alkaline Battery Adapter

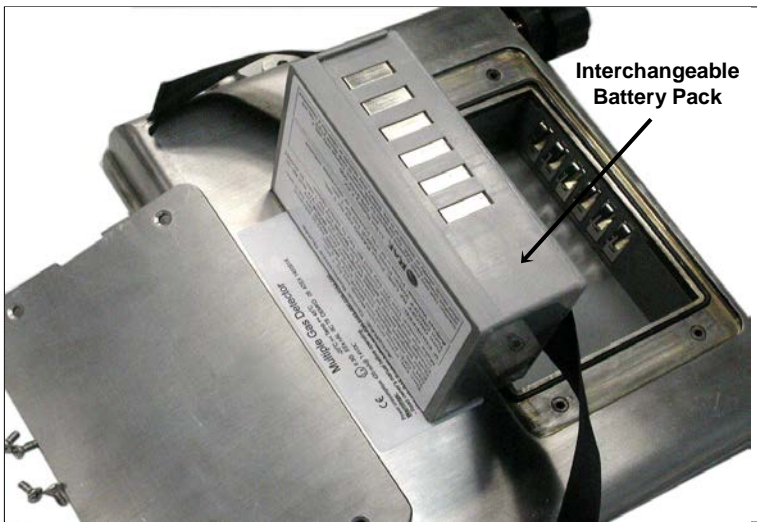
1. **Before** removing or replacing the battery pack, please make sure the AreaRAE is located in a non-hazardous area and is not connected to the charger.
2. To remove the battery pack, unscrew the four screws that secure the battery pack to the AreaRAE housing.
3. Remove and replace drained alkaline batteries. Use only DURACELL MN1400 or ENERGIZER E93 C size batteries with alkaline battery pack. Be sure to match the battery polarity as indicated by the diagram inside the battery holder.
4. Reattach the battery pack to monitor.

**NOTE:** The internal charging circuit automatically detects the alkaline battery adapter and will not charge the battery adapter.

## 3.2.2 AreaRAE Steel

An alkaline battery adapter is supplied with each the AreaRAE Steel and AreaRAE Gamma Steel kit. It may be used in place of the rechargeable Lithium-Ion battery pack to provide at least 24 hours of operation.

The alkaline pack holds 6 C-size alkaline batteries. Use only DURACELL MN1400 or ENERGIZER E93 C-size batteries with the AreaRAE Steel alkaline battery pack.



**Figure 3-2. Interchangeable Battery Packs**

### **Safety for Batteries**

The rechargeable Lithium-ion and alkaline battery packs are CSA Classified as Safe for use in the following areas:

Class I, Division II, Groups A, B, C, and D

### Recharging the Lithium-Ion Battery Pack

4. Turn off the power to the AreaRAE Steel.
5. Connect the AC adapter (or the optional automotive charging adapter) to the charger connection port on the AreaRAE Steel monitor.
6. A red “charge” LED located on the front of the instrument indicates that the battery is being charged. A completely drained AreaRAE Steel is typically fully charged within 10 hours.

### Removing or Replacing the Alkaline Battery Adapter

5. Before removing or replacing the battery pack, please make sure the AreaRAE Steel monitor is located in a non-hazardous area and is not connected to the charger.
6. To remove the battery pack, unscrew the four screws that secure the plate over the battery compartment. Remove the cover plate and lift the battery pack out of the AreaRAE Steel.



7. Remove and replace drained alkaline batteries. Use only DURACELL MN1400 or ENERGIZER E93 C size batteries with the alkaline battery pack. Be sure to match the battery polarity as indicated by the diagram inside the battery holder.
8. Reattach the battery pack to monitor, set it inside the AreaRAE Steel, and replace the cover plate.

**NOTE:** The internal charging circuit automatically detects the alkaline battery adapter and does not draw charge from the battery adapter.

### 3.3 External Filter

The external filter is made of a PTFE (Teflon<sup>®</sup>) membrane with a 0.2 micron pore size to prevent liquid water from being sucked into the sensor manifold, which would cause extensive damage to the monitor. It also prevents dust from entering the monitor and prolongs the sensors' operating life.

To install the External Filter, slide the Tygon tubing onto the ribbed inlet port of the monitor. A male Luer connector fits into the female Luer receptacle of the filter. To remove the filter, disconnect the Luer connector by unscrewing it.

There are some vapors that are especially reactive or easily absorbed by instrument surfaces; they include, but are not limited to: Cl<sub>2</sub>, PH<sub>3</sub>, NH<sub>3</sub>, HCN, and semi-volatile organic compounds like diesel fuel and jet fuel. For these compounds, the high pump speed setting should be used. (See Section 2.9: Integrated Sampling Pump.) It is also more desirable to use inert connecting and sampling tubing such as Teflon<sup>®</sup> instead and to make tube connections as short as possible.

### 3.4 Remote Sampling Probe

A 5-meter (15') length of Teflon<sup>®</sup> tubing is supplied as a standard accessory with every the AreaRAE Steel detector. An optional 6' Teflon<sup>®</sup> remote sampling probe with a telescoping handle is also available for the user who needs to probe hard-to-reach areas such as ceilings, storage tanks, underground manholes, etc.

Connect the male Luer connector to the end of the remote sampling probe or the Teflon<sup>®</sup> tubing to the female Luer connector on the External Filter. The remote sampling probe or the Teflon<sup>®</sup> tubing is ready for operation.

## 3.5 Dilution Fitting

An optional dilution fitting can be installed with the remote sampling probe or Teflon<sup>®</sup> tubing on the gas inlet port to dilute gas samples. This fitting is needed when the gas sample contains less than 15% oxygen. The combustible sensor does not function correctly when the oxygen concentration falls below 15%. The dilution fitting increases the oxygen concentration so the combustible sensor may still be used under oxygen deficient conditions. The dilution fitting may also be used to measure combustible, VOC or toxic gases when concentrations exceed the upper limit of the sensor range.

To use the dilution fitting, insert the fitting between the External Filter and the remote sampling probe or Tygon tubing. Set the dilution ratio in Program Mode so the correct gas reading displays when the dilution fitting is used. (See Section 4.8.4: Change Dilution Ratio.)



For this application, the monitor must be located in a clean atmosphere outside the confined space and a remote access probe or Teflon <sup>®</sup> tubing used to measure the gas concentration.
---

## 3.6 Calibration Adapter

The AreaRAE should be calibrated with the external filter in place. The AreaRAE calibration adapter is designed to slip over the filter. During calibration, connect the calibration adapter to the cylinder of the calibration gas. Then insert adapter into the filter and allow the gas to flow to sensors.

**NOTE:** The gamma radiation sensor in the AreaRAE Gamma and AreaRAE Gamma Steel is factory calibrated with a fixed gamma radiation source. There is no need to calibrate the gamma sensor in the field.

## 4. Programming the AreaRAE

The AreaRAE is built with a microprocessor to provide programming flexibility for the user. Authorized users may recalibrate the monitor, change alarm limits, change site ID, change user ID, change datalogging period, adjust the real-time clock, etc.

Program Mode is menu-based to provide user-friendly operation. The display shows menu options, and the key pad is used for menu selection and data entry.

**Note:** Real-time monitoring of gas concentrations continues during Program Mode. However, during calibration real-time monitoring pauses until procedures are finished. In addition, when Program Mode is entered, the datalogging operation automatically pauses. Upon exiting Program Mode, datalogging resumes. However, datalogging must be manually restarted if it is in manual datalog mode.



## 4.1 Program Mode

The AreaRAE has three user modes: **Text**, **Display** and **Program mode**. See Section 4.3: Entering Programming Mode for details.

The programming function allows changing the setup in the monitor, calibrating the monitor, modifying the sensor configuration, entering user information, etc. The programming functions are organized in a three-tier menu structure.

This is the first tier of the programming menu:

- Calibrate Monitor?
- Change Alarm Limits?
- Change Datalog?
- Change Monitor Setup?
- Change Sensor Configuration?

Each menu item includes several submenus with additional programming functions.

### **Security Level**

There are three levels of security in the Program Mode to prevent unauthorized changes to specific settings. Security levels are set by PC. See Section 4.3: Entering Programming Mode for details.

Once inside Program Mode, the first menu displays. Press [N/-] to view each menu option. Press [N/-] until the desired menu is displayed. To enter and display a submenu, press [Y/+].

To exit Program Mode to return to normal operation, press [MODE] at any of the first-tier menu options.

## 4.2 Keys for Program Mode

<b>Key</b>	<b>Function</b>
<b>[MODE]</b>	Exit menu when pressed momentarily, or exit data entry mode when pressed and held for 1 second.
<b>[Y/+]</b>	Increase numerical value for data entry. Answer “yes.”
<b>[N/-]</b>	Decrease numerical value for data entry. Answer “no.”

### 4.3 Entering Program Mode

1. Turn on the AreaRAE monitor (press [MODE] for three seconds and then release).
2. Press and hold [MODE] and [N/-] for three seconds to enter Program Mode. This prevents entering Program Mode by accident.
3. Security Level 0 or Level 2: the monitor enters Program Mode and the first menu item "Calibrate Monitor?" will display.
4. Security Level 1 or Text mode: "Enter Password = 0000" is displayed with the far left digit flashing. Enter the password, starting from the flashing digit.

<p><b>Note:</b> Prior to factory shipment, the default password of "0000" is programmed into the AreaRAE. For added security, "0000" is always displayed instead of the actual password, if you change it.</p>
--

5. If the digit value is not "0," use [Y/+] or [N/-] to increase or decrease digit value. Press [MODE] to confirm the digit's value. The display shows the actual digit entered and moves the flashing cursor to the next digit to the right.
6. Repeat Step 5 until all four digits are entered. Then press and hold [MODE] for one second.
7. If the entered password is correct, the monitor enters the programming menu. The first menu item, "Calibrate Monitor?" is displayed.
8. If the password is incorrect, the display shows "Wrong Password???" and returns to the regular display of instantaneous sensor readings.

## PROGRAMMING THE AREARAE

User Mode Security Level	Text			Display			Program		
	0	1	2	0	1	2	0	1	2
<b>Calibrate Monitor?</b>									
Fresh Air Calibration?	✓*	✓*	✓*	✓*	✓*	✓*	✓	✓*	✓
Multiple Sensor Calibration?	✓*	✓*	✓*	✓*	✓*	✓*	✓	✓*	✓
Single Sensor Calibration?	✓*	✓*	✓*	✓*	✓*	✓*	✓	✓*	✓
Modify Span Gas Value?	✓* #	✓*	✓*	✓* #	✓*	✓*	✓#	✓*	✓
Change LEL/VOC Span Gas?	✓* #	✓*	✓*	✓* #	✓*	✓*	✓#	✓*	✓
<b>Change Alarm?</b>									
Change High Alarm Limit?	✓* #	✓*	✓*	✓* #	✓*	✓*	✓#	✓*	✓
Change Low Alarm Limit?	✓* #	✓*	✓*	✓* #	✓*	✓*	✓#	✓*	✓
Change STEL Alarm Limit?	✓* #	✓*	✓*	✓* #	✓*	✓*	✓#	✓*	✓
Change Average Alarm Limit?	✓* #	✓*	✓*	✓* #	✓*	✓*	✓#	✓*	✓
<b>Change Datalog?</b>									
Clear All Data?	✓*	✓*	✓*	✓*	✓*	✓*	✓	✓*	✓
Change Datalog Period?	✓* #	✓*	✓*	✓* #	✓*	✓*	✓#	✓*	✓
Select Data Type?	✓* #	✓*	✓*	✓* #	✓*	✓*	✓#	✓*	✓
Enable/Disable Datalog?	✓*	✓*	✓*	✓*	✓*	✓*	✓	✓*	✓
<b>Change Monitor Setup?</b>									
Change Unit ID? (Unit & Host)	✓*	✓*	✓*	✓*	✓*	✓*	✓	✓*	✓
Change ID? (Site & User)	✓* #	✓*	✓*	✓* #	✓*	✓*	✓#	✓*	✓
Change Alarm Mode?	✓* #	✓*	✓*	✓* #	✓*	✓*	✓#	✓*	✓
Change User Mode?	✓* #	✓*	✓*	✓* #	✓*	✓*	✓#	✓*	✓
Change Real Time Clock?	✓* #	✓*	✓*	✓* #	✓*	✓*	✓#	✓*	✓
Change Light and Buzzer Mode?	✓*	✓*	✓*	✓*	✓*	✓*	✓	✓*	✓
Change Password?	✓* #	✓*	✓*	✓* #	✓*	✓*	✓#	✓*	✓
Change Pump Duty Cycle?	✓* #	✓*	✓*	✓* #	✓*	✓*	✓#	✓*	✓
Change Pump Speed?	✓* #	✓*	✓*	✓* #	✓*	✓*	✓#	✓*	✓
Change Average Method?	✓* #	✓*	✓*	✓* #	✓*	✓*	✓#	✓*	✓
Change Display Language?	✓* #	✓*	✓*	✓* #	✓*	✓*	✓#	✓*	✓
Set Temperature Unit?	✓* #	✓*	✓*	✓* #	✓*	✓*	✓#	✓*	✓
<b>Change Sensor Configuration?</b>									
Change LEL/VOC Gas Selection?	✓* #	✓*	✓*	✓* #	✓*	✓*	✓#	✓*	✓
Enable/Disable Sensor?	✓*	✓*	✓*	✓*	✓*	✓*	✓	✓*	✓
Change Dilution Ratio?	✓* #	✓*	✓*	✓* #	✓*	✓*	✓#	✓*	✓
Change PID Lamp Type?	✓* #	✓*	✓*	✓* #	✓*	✓*	✓#	✓*	✓
Change RAD unit? +	✓* #	✓*	✓*	✓* #	✓*	✓*	✓#	✓*	✓

✓ = Available    \* = Password Required    # = No change allowed  
 + = AreaRAE Gamma and AreaRAE Gamma Steel only

## 4.4 Calibrating the AreaRAE



The calibration of all newly purchased RAE Systems instruments should be tested by exposing the sensor(s) to known concentration calibration gas before the instrument is used or put into service. For maximum safety, the accuracy of the AreaRAE should be checked by exposing the sensor(s) to known concentration calibration gas before each day's use.

In Program Mode, you may recalibrate sensors in the AreaRAE monitor. This is a two-point calibration process using fresh air and the standard reference gas. First, fresh air, which contains 20.9% oxygen and no detectable VOC, toxic or combustible gases, is used to set the zero point for each sensor. Then a standard reference gas (also known as span gas), which contains a known concentration of a given gas, is used to set the second point of reference. The two-point calibration procedure is detailed on the next page.

These are the submenus for calibration operations:

- Fresh Air Calibration?
- Multiple Sensor Calibration?
- Single Sensor Calibration?
- Modify Span Gas Value?
- Change LEL/VOC Span Gas?

**NOTE:** The gamma radiation sensor in the AreaRAE Gamma and AreaRAE Gamma Steel is factory calibrated with a fixed gamma radiation source. There is no need to calibrate the gamma sensor in the field.

### 4.4.1 Fresh Air Calibration

This procedure determines the zero point of the sensor calibration curve. To perform fresh air calibration, the calibration adapter and a bottle of fresh air (optional) are required. The bottle of fresh air contains 20.9% oxygen concentration and contains no organic, toxic or combustible gases or other impurities. If a fresh air bottle is not available, any clean ambient air without detectable contaminants may also be used. A charcoal filter should be used if purity of the ambient air is unknown.

1. "Calibrate Monitor?" is the first menu item. Press [Y/+] to perform calibration. The first submenu is: "Fresh Air Calibration?"
2. If a bottle of fresh air is being used, attach the calibration adapter to the gas inlet port. Connect the other end of the tube to the bottle of fresh air. If a bottle of fresh air is not available, leave the monitor in an area free of any detectable vapors.
3. Press [Y/+] to start fresh air calibration. The display shows "zero...in progress" followed by the name of each sensor, and then the message "zeroed." The display should show a reading of "20.9" for the oxygen sensor and "0.0" or a very small number for all other sensors.
4. After a five-second pause, the display shows "Zero Cal Done!" and moves to the next submenu, "Multiple Sensor Calibration?"

## 4.4.2 Sensor Calibration Time

Refer to the RAE website, [www.raesystems.com](http://www.raesystems.com), and download Technical Note TN-114, Sensor Specifications And Cross Sensitivities, for current data and information regarding sensor calibration time.

Slowly responding sensors listed in TN-114 may require pre-exposure to the gas immediately before initiating the calibration sequence. Some firmware versions use a fixed 60-second calibration time; some newer versions automatically apply the full calibration time. After completing the zero calibration procedure, expose the unit to the gas for the pre-exposure time if a 60-second countdown time is programmed in the unit.

If the firmware has the full calibration time programmed in, the sensors must be calibrated in the Single Sensor mode to take advantage of this feature. The calibration time is set at 60 seconds in the Multiple Sensor mode and may not be changed.



### 4.4.3. Multiple-Sensor Calibration

This function simultaneously determines the second point of calibration curve for multiple sensors in the monitor. Mixed standard reference gases are needed to perform this procedure. You may choose several gas mixtures to be used in multiple-sensor calibration.

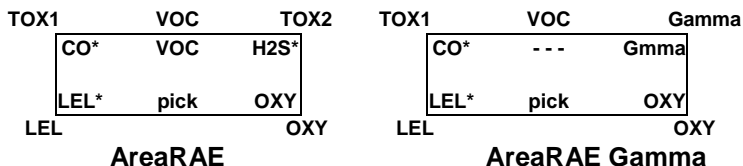
- Continuing from Step 4 of the previous section, "Multiple Sensor Calibration?" is the next display. Multiple-component calibration gas mixtures are available for a number of common AreaRAE sensor configurations. Press [Y/+] to continue if a multi-component gas is being used to calibrate instrument. The display asks you to verify which sensors will be calibrated using the multi-component mixture. Press [Y/+] to continue, or [N/-] to change the choice of sensors to be adjusted.

TOX1	VOC	TOX2	TOX1	VOC	Gamma
CO	---	H2S	CO	---	Gmma
LEL	OK?	---	LEL	OK?	---
LEL		OXY	LEL		OXY
<b>AreaRAE</b>			<b>AreaRAE Gamma</b>		

- Press [Y/+] to continue, and the instrument asks you to apply gas to the sensors. Connect the Luer fitting on the calibration gas adapter to the inlet of the AreaRAE Steel. Leave the External Filter in place during calibration.
- Turn the regulator valve on to start the flow of gas. When the calibration gas has reached the sensor, the display shows "calibration in progress... 60," and the countdown timer shows the remaining seconds while the monitor calibrates. When the countdown timer reaches 0, the display shows the name of each sensor, the message "cal'ed!" and the calibrated values for each gas. If the sensor does not detect any gas after 60 seconds, the display shows "No gas flow..." and aborts calibration.

**Note:** If the readings are very close to the span gas values, then the calibration was successful. If the readings are not close to the span gas values, then calibration has failed. Therefore, you must verify that the span gas value settings in the unit match the given values on the gas bottle. (Check the label on the gas bottle, and also make sure the gas bottle is not empty.) After a five-second pause, “Span Cal Done! Turn Off Gas” is displayed.

4. This completes the Multiple Sensor Calibration procedure and moves to the next submenu item, Single Sensor Calibration.
5. Turn off the gas flow. Disconnect the calibration tube from the monitor.
6. From Step 1 of this section, if [N/-] is pressed, the display shows all the sensor names, which are selected for multiple sensor calibration with the cursor blinking at the first sensor location.



Press [Y/+] to select the sensor and [N/-] to deselect the sensor. A previously selected sensor shows an “\*” next to the sensor name. A previously deselected sensor does not show an “\*” next to the sensor name.

7. Press [MODE] to move from one sensor location to the next. Repeat Step 7 until all sensors that need to be calibrated during multiple sensor calibration have been selected. Press and hold [MODE] for one second to save the new sensor selection.
8. The “Save?” display now appears. To confirm the new selection, press [Y/+] to accept the change and continue to Step 2. Press [N/-] or [MODE] to discard the change and to continue on with Step 2.

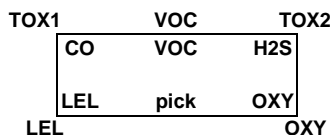
### **Cross-Sensitivity**

Some sensors may show cross-sensitivity to other gases. Therefore, it is important to choose the gas mixture carefully for the Multiple Sensor Calibration to avoid erroneous readings. For example, some VOC gases are known to cause erroneous readings by the CO sensor. In general, it is recommended to calibrate the two toxic sensors, combustible and oxygen sensor with a bottle of mixed gas using the Multiple Sensor Calibration procedure and to calibrate the PID with a bottle of a single VOC gas. Use the Single Sensor Calibration procedure for the oxygen sensor 0% O<sub>2</sub> (100% N<sub>2</sub>) calibration, if needed.

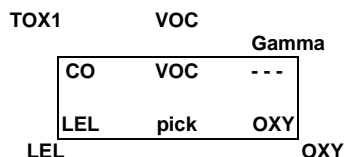
### 4.4.4 Single-Sensor Calibration

This procedure determines the second point of the sensor calibration curve for a single sensor. A standard reference gas (span gas) is needed to perform this procedure. Table 2.2 (Alarm Limits and Conditions) shows the standard calibration gas typically used as the span gas at the factory.

- Continuing from Step 4 or Step 6 of the previous section, the display should show “Single Sensor Calibration?” Press [Y/+]. The display shows all the installed sensors in the monitor with the cursor blinking at the first sensor location. Press [Y/+] to select the highlighted sensor and start the calibration. Or press [MODE] to move to the next sensor location.

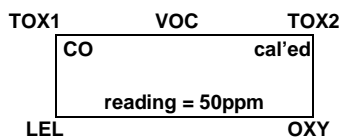


**AreaRAE**

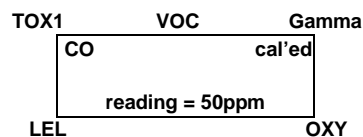


**AreaRAE Gamma**

- Turn on the valve of the CO gas bottle to start gas flow. Display shows “Apply CO Gas” and waits for the calibration gas to reach the sensor. Once the sensor detects the gas, “Calibration in progress... 60” appears with the countdown timer showing the remaining seconds as the monitor calibrates. When the countdown timer reaches 0, the display shows the sensor name and the calibrated value:



**AreaRAE**



**AreaRAE Gamma**

If the sensor does not detect any gas after 60 seconds, “No gas flow...” is displayed and calibration is aborted.

**Note:** The reading should be very close to the span gas value. After a five-second pause, “Span Cal Done! Turn Off Gas” appears in the display.

3. This completes the single-gas calibration procedure for one sensor. The display shows the single-gas calibration submenu for a user to select another sensor or move to the next submenu, Modify Span Gas Value.
4. Turn the gas flow off. Disconnect the calibration tube from the AreaRAE Steel.
5. Repeat Step 1 through Step 3 to calibrate the next sensor.
6. Press [MODE] to stop the countdown timer and abort the calibration during Step 1. If a sensor fails calibration, the sensor name and the error message “failed, continue? ” appears. Press [N/-] or [MODE] to abort calibration and move to the next submenu item. Press [Y/+] to continue single-gas calibration. In either case, the current calibration data is not changed.

### Oxygen Sensor Calibration

The oxygen sensor calibration is slightly different from the other sensors. The oxygen sensor measures a range of 0 to 30% of oxygen in the air. During fresh air calibration, the oxygen sensor is calibrated to a fixed percentage of 20.9% oxygen. During single-sensor calibration, you may supply a pure nitrogen gas so the oxygen sensor may be calibrated to 0% oxygen. You may also supply other span concentrations of the oxygen (for example, 19.5%), to calibrate the oxygen sensor. When “0% oxygen?” appears, enter [Y/+] if the pure nitrogen gas is used to calibrate the oxygen sensor. Otherwise, enter [N/-] to calibrate the oxygen sensor to another span oxygen value. During either single- or multiple-sensor calibration, the oxygen sensor is calibrated to the span value. (See Section 4.4.5: Modify Span Gas Value.)

<p><b>Note:</b> After a 0% oxygen calibration, you must perform a fresh air calibration to ensure that the oxygen sensor is calibrated correctly.</p>
---

### Calibration Time Stamp

When a single- or multiple-sensor calibration is performed, a time stamp is stored in the non-volatile memory. This information is included in the datalogging report.

## 4.4.5 Modify Span Gas Value

This function allows changing the span values of the standard calibration gases.

1. The next submenu is "Modify Span Gas Value?"
2. Press [Y/+], and the following display appears:

TOX1	VOC	TOX2	TOX1	VOC	Gamma
50	100	10	50	100	20.9
50	span	20.9	50	span	20.9
LEL		OXY	LEL		OXY
<b>AreaRAE</b>			<b>AreaRAE Gamma</b>		

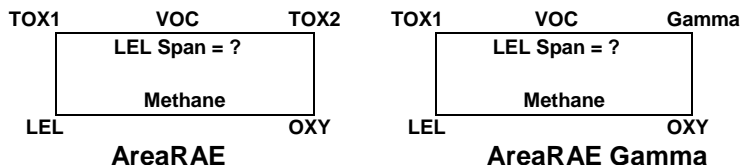
The blinking cursor is on the first digit of the first span value. To modify any of the span gas values, go to Step 3. Otherwise, press and hold [MODE] for one second to accept the previously stored span gas value and advance to the next submenu, Change LEL/VOC Span Gas.

3. Starting from the far left digit of the span gas value, use [Y/+] or [N/-] to change the digit value and press [MODE] to move to the next digit to the right. Repeat until all span gas values have been entered. Press and hold [MODE] for one second to save the new calibration gas value.
4. The display shows "Save?" To confirm the new value, press [Y/+] to accept the change. Press the [N/-] or [MODE] to discard the change and move to the next calibration submenu.

## 4.4.6 Change LEL/VOC Span Gas

This function allows the user to select a specific LEL or VOC gas to be used as the span gas during LEL or VOC gas calibration.

1. When the "Change LEL/VOC Span Gas?" submenu appears, press [Y/+]. If the LEL sensor is installed and enabled, the display shows:



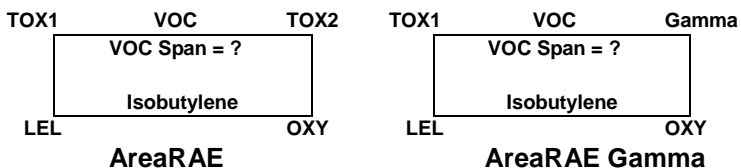
Otherwise, the message "No LEL installed" appears.

2. If you do not want to change the LEL span gas, press [Y/+] to accept the current selection and exit this submenu.
3. If you want to select a different LEL span gas, press [N/-]. Then use [Y/+] or [N/-] to scroll through a list of gas names until a desired gas name appears in the LCD display. Now press [MODE] to select the new gas name.
4. The display shows "Save?" To confirm the new gas selection, press [Y/+] to accept the change. Press [N/-] or [MODE] to discard the change and move to the next display.

## PROGRAMMING THE AREARAE

---

5. If the VOC sensor is installed and enabled, the display shows:



Otherwise, the message “No VOC installed” is shown.

6. If you do not want to change the VOC span gas, press [Y/+] to accept the current selection and exit this submenu.
7. If you want to select a different VOC span gas, press [N/-] first then use [Y/+] or [N/-] to scroll through a list of gas names until a desired gas name appears in the LCD display. Now press [MODE] to select the new gas name.
8. The display shows “Save?” To confirm the new gas, press [Y/+] to accept the change. Press [N/-] or [MODE] to discard the change and return to the first calibration submenu.



## 4.5 Change Alarm Limits

You may change each sensor's alarm limits while in Program Mode.

These are the submenus for changing the alarm limits:

Change High Alarm limit?

Change Low Alarm limit?

Change STEL alarm limit?

Change Average alarm limit?

- The items in the submenu allow changing the high alarm limit, low alarm limit, STEL alarm limit, or average alarm limit. The average alarm limit can be "Running Average" or "TWA (Time Weighted Average)" depending on the menu selection on "Change Averaging Method" (see Section 4.7.8). Press [N/-] to cycle through the submenu. Press [Y/+ ] to enter a submenu and the display shows "HIGH", "LOW," "STEL," "TWA," or "AVG" with a flashing cursor on the left-most digit of the previously stored alarm limits.

TOX1	VOC	TOX2
200	100.0	20
20	HIGH	23.5
LEL		OXY

**AreaRAE**

TOX1	VOC	Gamma
200	100.0	250
20	HIGH	23.5
LEL		OXY

**AreaRAE Gamma**

TOX1	VOC	TOX2
35	50.0	10
10	LOW	23.5
LEL		OXY

**AreaRAE**

TOX1	VOC	Gamma
35	50.0	100
10	LOW	23.5
LEL		OXY

**AreaRAE Gamma**

TOX1	VOC	TOX2
100	25.0	15
STEL		
LEL		OXY

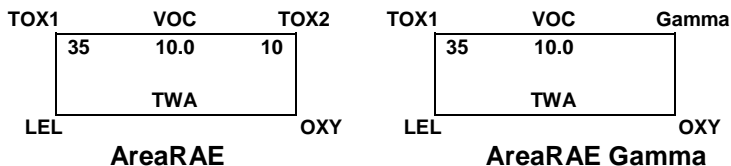
**AreaRAE**

TOX1	VOC	Gamma
100	25.0	
STEL		
LEL		OXY

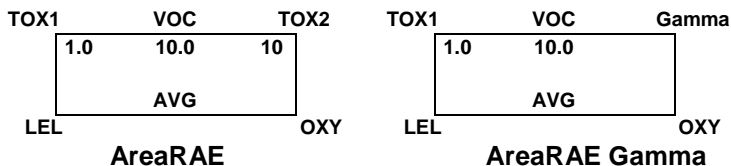
**AreaRAE Gamma**

## PROGRAMMING THE AREARAE

---



Alternatively, if the Averaging Method is the Running Average, the AVG is displayed instead of the TWA. (See Section 4.7.9: Change Averaging Method.)



2. To modify this limit, starting from the left-most digit, use [Y/+] or [N/-] to change the digit value, and press [MODE] momentarily to advance to the next digit. The flashing digit moves on to the next digit to its right. Repeat this process until all the new alarm limits are entered. Press and hold [MODE] for 1 second to exit data entry mode. If there is any change to the existing value, the display shows "Save?" Press [Y/+] to accept the new value and move to the next submenu. Press the [N/-] to discard the changes. To preserve the previously stored alarm limit, press and hold [MODE] for 1 second and the monitor exits data entry mode and moves to the next submenu.

## 4.6 Change Datalog

The AreaRAE calculates and stores the gas readings at a specified interval. (AreaRAE Gamma and AreaRAE Steel also store gamma radiation readings.) You can change datalog setup from the Program Mode. You can also program additional datalog options by downloading from the PC to the AreaRAE Steel monitor.

These are the submenus for Datalog options:

Clear All Data?

Change Datalog Period?

Select Data Type?

Enable / Disable Datalog?

### **4.6.1 Clear All Data**

This function erases all data stored in the non-volatile datalog memory. This does not change STEL, TWA, Peak, minimum concentration and run time values that are stored in the other location.

1. "Clear All Data?" is the second item in the Datalog submenu.
2. Press [Y/+] to clear the data memory. The display shows "Are You Sure?" to reconfirm the clearing of memory.
3. Pressing [Y/+] again erases all the data memory.
4. Press the [N/-] or [MODE] to exit without clearing the data memory and move to next datalog submenu.

## 4.6.2 Change Datalog Period

The datalog period can be programmed from 1 to 3,600 seconds (1 hour).

1. "Change Datalog Period?" is the third item in the Datalog Program submenu item.
2. Press [Y/+], and the display shows "New Period = 0060" with the left-most digit flashing, where "0060" is the previously stored data log period.
3. To modify this period, start from the left-most digit and use the [Y/+] or [N/-] to change the digit value. Then press [MODE] momentarily to advance to the next digit. The flashing digit advances to the next digit to the right. Repeat this process until all four digits of the new period are entered. Press and hold [MODE] for 1 second to exit data entry mode. If there is any change to the existing value, the display shows "Save?" Press [Y/+] to accept the new value and exit the datalog submenu. Press [N/-] to discard the changes and move to the next menu option.
4. To preserve the previously stored period, press and hold [MODE] for 1 second. The monitor exits data entry mode and moves to the next submenu item.

### 4.6.3 Select Data Type

You can choose to store either the average or the peak value during each datalog period.

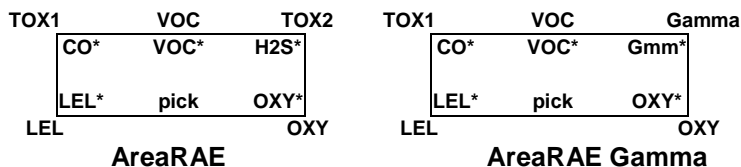
1. When the “Select Data Type?” submenu item appears, press [Y/+]. The display shows the current data type: “Data Type = Average?”
2. If you press [Y/+], it accepts the currently displayed data type and automatically goes into View Datalog. If you press [N/-] it changes to the other data type: “Data Type = Peak?” Press [MODE] to exit this submenu and move on to the next submenu.
3. To change the existing selection, press [Y/+]. The display shows “Save?” Then press [Y/+] to accept, or [N/-] to discard and move to the next submenu.

<p><b>Note:</b> It is necessary to select “Average” data type in order to calculate the correct STEL and TWA data for a datalogging report.</p>
---

## 4.6.4 Enable/Disable Datalog

You can choose to enable or disable the datalogging function on each individual sensor. This allows selective logging of certain sensor readings of interest.

1. When “Enable / Disable Datalog?” appears, press [Y/+]. The display shows the entire installed sensor in the monitor. A previously selected sensor to be datalogged is marked with an “\*” next to the sensor name. The cursor is blinking at the first sensor location. Press [Y/+] to enable the datalogging for the sensor and [N/-] to disable the datalogging.



2. Press [MODE] momentarily to move from one sensor location to the next one. Repeat Step 2 until all the sensors that need to be datalogged are selected. Press and hold [MODE] for 1 second to save the new sensor selection.
3. The display shows “Save?” To confirm the new selection, press [Y/+] to accept the change. Press [N/-] or [MODE] to discard the change and return to the first datalog submenu.

## 4.7 Change Monitor Setup

In the Program Mode, you may change monitor setup or enter user information for the AreaRAE.

### Monitor Setup submenu:

User Mode	Refer to section
Change Site ID?	4.7.1
Change User ID?	4.7.2
Change Alarm Mode?	4.7.3
Change User Mode?	4.7.4
Change Real-time Clock?	4.7.5
Change Light and Buzzer Mode?	4.7.6
Change Password?	4.7.7
Change Pump Duty Cycle?	4.7.8
Change Pump Speed?	4.7.9
Change Averaging Method?	4.7.10
Change Display Language?	4.7.11
Set Temperature Unit?	4.7.12



## 4.7.1 Change Site ID

To change the Site ID, you must enter an eight-digit alphanumeric site ID in the Program Mode. This site ID is then included in the datalog report.

1. "Change Site ID?" is the first submenu item. Press [MODE] to choose one of them and press [Y/+]. The display shows the current site ID: "Site ID = xxxxxxxx" with the left-most digit flashing.
2. Press the [Y/+] or [N/-] to cycle through all 26 letters and 10 numerals. Press [MODE] momentarily to advance to the next digit. The flashing digit moves to the next digit to the right. Repeat this process until all 8 digits of the new site ID are entered.
3. Press and hold [MODE] for 1 second to exit the data entry mode and move to the next monitor setup submenu.
4. If there is any change to the existing site ID, the display shows "Save?" Press [Y/+] to accept the new site ID and exit the monitor setup submenu. Press [N/-] to discard the changes and move to the next submenu.

## 4.7.2 Change User ID

To change the User ID, enter an eight-digit alphanumeric user ID in the Program Mode. This user ID is then included in the datalog report.

1. "Change User ID?" is the second submenu item. Press [Y/+] and the display shows the current user ID: "User ID=xxxxxxx" with the left digits flashing.
2. Press [Y/+] or [N/-] to cycle through all 26 letters and 10 numerals. Press [MODE] momentarily to advance to the next digit. The flashing digit moves to the next digit to its right. Repeat this process until all 8 digits of the new user ID are entered.
3. Press and hold [MODE] for 1 second to exit the data entry mode and move to the next monitor setup submenu.
4. If there are any changes to the existing user ID, the display shows "Save?" Press [Y/+] to accept the new user ID and exit the monitor setup submenu. Press [N/-] to discard the changes and move to the next submenu.

### 4.7.3 Change Alarm Mode

There are two different alarm modes that can be selected from the programming menu in the AreaRAE, latched and auto reset:

1. "Change Alarm Mode?" is the third submenu item. Press [Y/+], the display shows the current alarm mode selection: "Alarm Mode = Latched?"
2. Press [Y/+] to accept the currently displayed alarm mode. Press [N/-] to change to the other alarm mode: "Alarm Mode = Auto Reset?" Press [MODE] to exit this submenu and move to the next monitor setup submenu.
3. If there is any change to the existing selection, press [Y/+] and the display shows "Save?" Then press [Y/+] to accept or [N/-] to discard and move to the next submenu.

## 4.7.4 Change User Mode

You can select three different user modes from the programming menu: program, display, and text.

1. "Change User Mode?" is the fourth submenu item. Press [Y/+], the display shows the current user mode selection: "User Mode = Program?"
2. Press [Y/+] to accept the currently displayed user mode. Press [N/-] to scroll through the other two user modes. Press [MODE] to exit this submenu and move to the next monitor setup submenu.
3. If there is any change to the existing selection, press [Y/+] and the display shows "Disable Program! Are you Sure?" Then press [Y/+] to accept or [N/-] to discard and move to the next submenu.

## 4.7.5 Change Real-time Clock

The AreaRAE is equipped with a real-time clock. You can enter the correct date and time into the real-time clock in the Program Mode.

1. “Change Real-time Clock?” is the fifth submenu item. Press [Y/+] and the display shows both the current date and time: “Date = April 01, '05” and “Time = hh : mm” with the left-most digit of the date flashing.
2. To modify this value, use the [Y/+] or [N/-] to change the digit value and press [MODE] momentarily to advance to the next digit. The flashing digit advances on to next digit to its right. Repeat this process until the new date and time values are entered. Press and hold [MODE] for 1 second to exit data entry mode. If there is any change to the existing value, the display shows “Save?” Press [Y/+] to accept the new value and move to next submenu. Press the [N/-] to discard the changes and move to next submenu.

## 4.7.6 Change Light and Buzzer Mode

The AreaRAE allows you to turn the light and buzzer on or off. The factory settings are saved to have both the light and buzzer turn on during alarm conditions. However, after you change and save the settings, that particular setting appears the next time you enter this menu to change the options again.

1. At the screen “Change Light & Buzzer Mode?” press [Y/+] to view submenus. Otherwise, press [N/-] to advance to the Change Password menu.
2. When the display “Light & Buzzer = Both On?” appears, press [Y/+] to accept the option and advance to the Change Password menu; the light turns on and the buzzer sounds during alarm conditions. Otherwise, press [N/-] to decline and move to the next submenu.
3. When the display “Light & Buzzer = Light Only?” appears, press [Y/+] to accept and only the light turns on during alarm conditions. Otherwise, press [N/-] to decline and the “Light & Buzzer = Buzzer Only?” screen appears. Press [Y/+] to accept and advance to the Change Password menu; only the buzzer sounds during alarm conditions. Otherwise, press [N/-] to decline and move to next submenu.
4. When the display “Light & Buzzer = Both off?” appears, press [N/-] to return to step 1, or press [Y/+] to accept and advance to the Change Password menu; neither the light nor the buzzer sounds during alarm conditions.

## 4.7.7 Change Password

You can modify the password from the monitor.

1. When the screen “Change Password?” appears, press [Y/+] and the display shows the current password: “Enter new password = xxxx” with the left-most digit flashing.
2. Press [Y/+] or [N/-] to cycle through all 10 numerals. Press [MODE] momentarily to advance to the next digit. The flashing digit moves to the next digit to the right. Repeat this process until all four digits of the new password are entered.
3. Press and hold [MODE] for 1 second to exit the data entry mode and move to the next monitor setup submenu.
4. If there is any change to the existing password, the display shows “Save?” Press [Y/+] to accept the new password. Press [N/-] to discard the changes and move to the next submenu.
5. Next, the monitor asks to confirm this value, “Confirm New Password = 0000” with the far left digit blinking. Re-enter the number as before to exit the Monitor Setup submenu. If the number is not entered correctly a second time, the password reverts to its original setting.

## 4.7.8 Change Pump Duty Cycle

A duty cycle is the ratio of the time the pump is on during 10-second periods. For example, a 30% duty cycle means that the instrument turns the pump on for three seconds, and then turns the pump off for seven seconds. You may control the time the pump is on during the specified 10-second period. Currently, users may only set the duty cycle from 20% (2 seconds) to 100% (10 seconds) with 10% (1 second) increments.

Increasing the duty cycle gives the instrument more time to clean its lamp, reducing lamp contamination and slowing the rate of signal degradation.

A disabled duty cycle means the pump is always on. The pump duty cycle is disabled when the reading is higher than 2.0 ppm and is enabled when the reading drops below 1.6 ppm. Users may also disable the duty cycle by setting the duty cycle to 100%. The duty cycle is also disabled during system warm-up, PC communication mode and calibration mode.

1. At the “Change Duty Cycle?” display, press [Y/+] to enter this menu. Otherwise, press [N/-] to advance to the next menu option, “Change Pump Speed?”
2. Next, the screen “New Duty Cycle =” appears with a percentage value following it. If the percentage is less than 100%, then press [Y/+] to increase the duty cycle by 10%. If the percentage is greater than 20%, then press [N/-] to decrease the duty cycle by 10%.
3. Once the specified value has been selected, press [MODE] for three seconds. The screen “Value Changed?” appears. If no values have been changed, the unit advances to next menu option, “Change Pump Speed?”
4. If values have been changed, you may save changes when the screen “Save?” appears by pressing [Y/+] . A “Save!” message confirms changed settings have been saved.
5. If you decide not to save changes to settings, then press [N/-] when “Save?” appears. The AreaRAE Steel advances to next menu option, “Change Pump Speed?”



### 4.7.9. Change Pump Speed

Two speed settings for the pump motor can be selected from the programming menu: low (default) and high. The “high” setting (400cc flow per minute) should be used for long lengths of tubing or when rapid changes in input conditions are expected. The “Low” setting (300cc flow per minute) may be selected when the operating conditions are slow to change. Low may also be used to prolong pump motor life, LEL sensor life and battery run time.

1. When the “Change Pump Motor Speed?” display appears, press [Y/+]. The display shows the current pump speed selection: “Pump Speed = Low?”
2. Press [Y/+] to accept the currently displayed pump speed and move to the next monitor setup submenu. Press [N/-] to change to the other speed, “Pump Speed = High?” Press [MODE] to exit this submenu and move to the next monitor setup submenu.

## 4.7.10 Change Averaging Method

There are two methods of calculation used in the averaging of the monitor. Using this selection can cause the calculation to be performed using an eight-hour time-weighted average (TWA), the default, or a running average (AVG). The display indicator for the selected averaging type shows on the LCD display wherever the average is indicated.

1. When the “Change Averaging Method?” screen appears, press [Y/+]. The display shows the current average selection: “Average Type = TWA?”
2. If you press [Y/+], it accepts the currently displayed type and automatically goes into Change Site ID. If you press [N/-], it changes to the other selection: “Average Type = Running Average?” Press [Y/+] to select it.
3. If there is any change to the existing selection, pressing [Y/+], the display will show “Save?” Then, press [Y/+] to accept or [N/-] to discard and move to the first setup submenu.

## 4.7.11 Change Display Language

You may choose to view the display menus in Spanish.

1. When the “Change Display Language?” screen appears, press [N/-] to keep the language setting in English. The AreaRAE Steel advances to next menu option, “Set Temperature Unit?”
2. To switch the language to Spanish, press [Y/+] to enter submenu “Change Language = Spanish.” Press [Y/+] again to confirm your selection. The AreaRAE Steel advances to next menu option, “Set Temperature Unit?” Otherwise, press [N/-] to return to step 1.

## 4.7.12 Set Temperature Unit

You may change the temperature unit from Fahrenheit to Celsius (factory setting), or back to Fahrenheit from Celsius.

1. At the “Set Temperature Unit?” display, press [Y/+]. The next screen to appear is either “Temperature Unit = Fahrenheit?” or “Temperature Unit = Celsius?”
2. Press [N/-] to toggle between units of measurement. Then press [Y/+] when the desired unit appears on screen.
3. When the “save?” screen appears, press [Y/+] to accept new settings and advance to the next menu option, Change Sensor Configuration. Otherwise, press [N/-] to go back to step 1.

## 4.8 Change Sensor Configuration

In Program Mode, you may change several sensor-related configurations of the AreaRAE monitor. The Sensor Configuration Submenu contains these configurations:

Change LEL/VOC Gas Selection?

Enable / Disable Sensors?

Change Dilution Ratio?

Change PID Lamp Type?

Change RAD Unit? \*

\* On AreaRAE Gamma and AreaRAE Gamma Steel only.

Before these submenus are described, the term “Correction Factor” needs to be explained:

### 4.8.1 Correction Factor

The PID and LEL sensor used in the AreaRAE are broadband sensors (that is, they respond to a broad range of gases). These sensors typically show a different sensitivity to different gases. The correction factor for a specific gas is defined as:

$$\text{Correction Factor} = \frac{\text{Sensitivity to a calibration gas}}{\text{Sensitivity to a specific gas}}$$

Correction factors are often used to obtain a calculated concentration of a specific gas while using a different gas during calibration.

The AreaRAE stores three sets of correction factors: One for the LEL sensor, one for the 10.6 eV PID sensor and the other for the 11.7 eV PID sensor. Each set consists of 20 to 40 different gases. You can choose one gas from the list to be the calibration gas and another gas to be the measurement gas.

For example, you can choose methane as the calibration gas for the LEL sensor and select pentane as the measurement

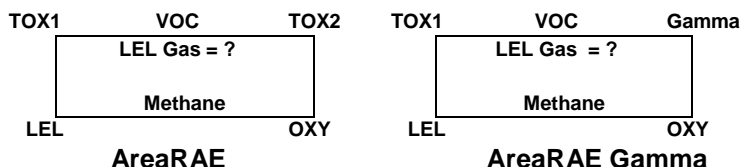
gas. The AreaRAE calculates the correction factor between these two gases and converts the measured value of the LEL sensor into an equivalent concentration of the pentane gas.

Similarly, you can choose one VOC gas for calibration and another VOC gas for measurement. In addition, the correction factor is different for the PID sensor due to different energy of the UV lamp used in the PID sensor. You must choose the correct type of UV lamp (10.6 eV ) for the PID sensor, which is described in Section 4.8.5: Change PID Lamp Type.

## 4.8.2 Change LEL/VOC Gas Selection

This function allows a choice of one of the pre-stored LEL or VOC gases in the monitor and calculate its correction factor relative to the LEL or VOC calibration gas. This factor will then be used during gas measurements to show the equivalent concentration of the selected LEL or VOC gas. The user can also modify this relative correction factor to increase or decrease the gas reading. This allows the user to create a custom factor for a specific gas or mixture of gases.

1. "Change LEL/VOC Gas Selection?" is the first submenu item. Press [Y/+]. If an LEL sensor is installed, the display shows:



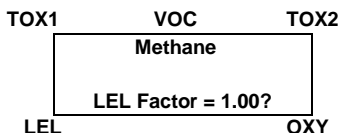
Otherwise, the message "No LEL installed" is displayed, and skip to Step 8.

2. If you do not want to change the LEL measurement gas, press [Y/+] to accept the current gas and skip to Step 6.
3. If you want to modify the LEL measurement gas, press [N/-] first, then use [Y/+] or [N/-] to scroll through a list of gas names until the desired gas name appears in the LCD display, then press [MODE] to select the new gas name.
4. The display shows "Save new gas?" To confirm the new gas, press [Y/+] to accept the change. Press the [N/-] or [MODE] to discard the change and move to the next step.

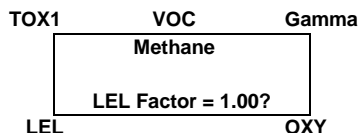
## PROGRAMMING THE AREARAE

---

5. "1.00" is the calculated correction factor of the selected gas in Step 4.

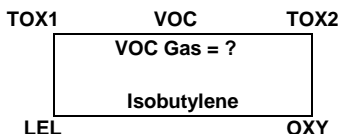


**AreaRAE**

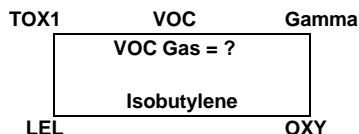


**AreaRAE Gamma**

6. If you do not want to modify the LEL correction factor, press [Y/+] and go to Step 8. To modify this factor, press [N/-] first. Then starting from the left-most digit, use the [Y/+] or [N/-] to change the digit value and press [MODE] momentarily to advance to the next digit. The flashing digit will move on to next digit to its right. Repeat this process until all 4 digits of the new factor are entered. Press and hold [MODE] for 1 second to exit data entry mode. If there is any change to the existing value, the display shows "Save?" Press [Y/+] to accept the new value and exit the gas selection submenu. Press the [N/-] to discard the changes.
7. If the VOC sensor is installed, the display shows:



**AreaRAE**



**AreaRAE Gamma**

Otherwise, the message "No VOC installed" is displayed and moves to the next submenu.

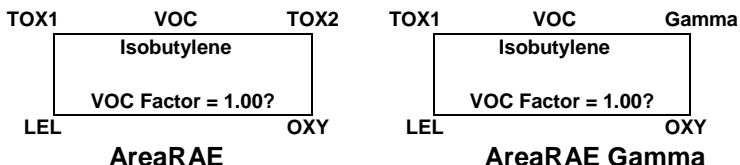
8. If you do not want to change the VOC measurement gas, press [Y/+] to accept the current gas and go to Step 12.
9. If you want to modify the VOC measurement gas, press [N/-] first, then use [Y/+] or [N/-] to scroll through a list of gas names until the desired gas name appears in the LCD display, then press [MODE] to select the new gas name.
10. The display shows "Save?" To confirm the new gas, press [Y/+] to accept the change. Press [N/-] or [MODE] to discard the change and move to the next step.



## PROGRAMMING THE AREARAE

---

11. "1.00" is the calculated correction factor of the selected gas in Step 10.



12. If you do not want to modify the VOC correction factor, press [Y/+] and exit the submenu. To modify this factor, press [N/-] first. Then starting from the left-most digit, use [Y/+] or [N/-] to change the digit value, and press [MODE] momentarily to advance to the next digit. The flashing digit will move on to next digit to its right. Repeat this process until all 4 digits of the new factor are entered. Press and hold [MODE] for 1 second to exit data entry mode. If there is a change to the existing value, the display shows "Save?" Press [Y/+] to accept the new value and exit the gas selection submenu. Press [N/-] to discard the changes.

### 4.8.3 Enable/Disable Sensor

This function allows you to selectively enable or disable individual sensors in the AreaRAE. When a sensor is disabled, the sensor does not measure or display the gas concentration.

1. "Enable / Disable Sensors?" is the second submenu. Press [Y/+]. The display shows all the installed sensors in the monitor. A previously enabled sensor is marked by an "\*" next to the sensor name. The cursor blinks at the first sensor location. Press [Y/+] to enable the sensor and [N/-] to disable the sensor.

TOX1	VOC	TOX2
CO*	VOC*	H2S*
LEL*	pick	OXY*

LEL OXY

**AreaRAE**

TOX1	VOC	Gamma
CO*	VOC*	Gmm*
LEL*	pick	OXY*

LEL OXY

**AreaRAE Gamma**

2. Press [MODE] momentarily to move from one sensor location to the next one. Repeat Step 2 until all the sensors that need to be enabled are selected. Press and hold [MODE] for 1 second to save the new sensor selection.
3. The display shows "Save?" To confirm the new selection, press [Y/+] to accept the change. Press [N/-] or [MODE] to discard the change and move to the next submenu.

## 4.8.4 Change Dilution Ratio

You can connect an optional dilution fitting to the AreaRAE's gas inlet port to dilute the gas sample. Enter a dilution ratio (from 1 to 10) from the programming menu so that the reading can be compensated to show the actual concentration of the gas sample with the dilution fitting:

1. "Change Dilution Ratio?" is the third submenu item. Press [Y/+], and the display shows the current dilution ratio: "Dilution Ratio = xx" with the left-most digit flashing.
2. Press the [Y/+] or [N/-] to increase or decrease the value of the digit. Press [MODE] momentarily to advance to the next digit. The flashing digit moves to the next digit to the right. Repeat this process until both digits of the new dilution ratio are entered.
3. Press and hold [MODE] for 1 second to exit the data entry mode and move to the next submenu.
4. If there is any change to the existing dilution ratio, the display shows "Save?" Press [Y/+] to accept the new ratio and exit the submenu. Press [N/-] to discard the changes and move to the next submenu.

## 4.8.5 Change PID Lamp Type

This programming menu only applies to the monitor equipped with a PID detector option. There are two different energy UV lamps available for the PID sensor: 10.6 eV . You user must select a lamp in order for the instrument to calibrate correctly.

1. "Change PID Lamp Type?" is the fourth submenu item. Press [Y/+], and the display shows the current PID lamp selection: "PID Lamp = 10.6 eV?"
2. Press [Y/+] to accept the currently displayed PID lamp and automatically advance to Change LEL/VOC Gas Selection. Press [N/-] to switch to the other lamp. Press [MODE] to exit this submenu and return to the first submenu.
3. If there is any change to the existing selection, press [Y/+] and the display shows "Save?" Then, press [Y/+] to accept or [N/-] to discard and return to the first submenu.

## 4.8.6 Change RAD Unit (Gamma Models)

This programming menu on the AreaRAE Gamma and AreaRAE Gamma Steel allows you to choose the display unit for radiation measurement. The default display unit is  $\mu\text{R}/\text{h}$ .

1. "Change RAD Unit" is the fifth submenu item. Press [Y/+] and the current radiation unit selection is: "RAD Unit =  $\mu\text{R}/\text{h}$ ?"
2. Press [Y/+] to accept the current selection and go to the next submenu. Press [N/-] to switch to  $\mu\text{Sv}/\text{h}$ . Press [MODE] to exit this submenu and return to the first submenu.

If there is any change to the existing selection, press [Y/+] and the display will show "Save?" Then, press [Y/+] again to accept or press [N/-] to discard changes and return to the first submenu.

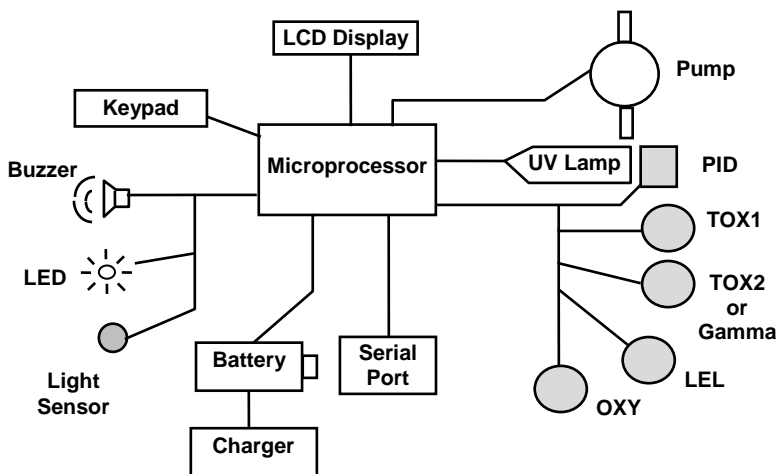
## 4.9 Exit Program Mode

To exit Program Mode from the first-tier menu level, press [MODE] once.

1. Display shows an instantaneous reading of normal operation mode.
2. To exit Program Mode from second-tier submenu level, press [MODE] twice.
3. To return to Program Mode, press and hold down both [MODE] and [N/-] for three seconds.

## 5.0 Theory of Operation

The AreaRAE uses one to five different sensors to measure a variety of gases. A newly developed electrodeless discharge UV lamp is used as the high-energy photon source for the PID sensor (see Figure 5-1). The patented PID sensor detects a broad range of organic vapors. Up to two electrochemical toxic gas sensors can be installed in the monitor to measure inorganic toxic gases. Many different types of toxic sensors are offered. They can be plugged into these two sensor sockets and are interchangeable. A catalytic bead sensor is used to measure combustible gases. An electrochemical sensor is used to measure oxygen concentration. In the AreaRAE Gamma and AreaRAE Gamma Steel, a gamma radiation sensor is used in place of the second toxic gas sensor.



**Figure 5-1** Block Diagram of the AreaRAE Monitor

## THEORY OF OPERATION

---

The PID sensor for the AreaRAE is located in a small cavity in front of the UV lamp. The other sensors are mounted next to the PID sensor. A diaphragm pump is installed inside the monitor enclosure to draw an air sample into the sensor manifold and then distribute it to all sensors.

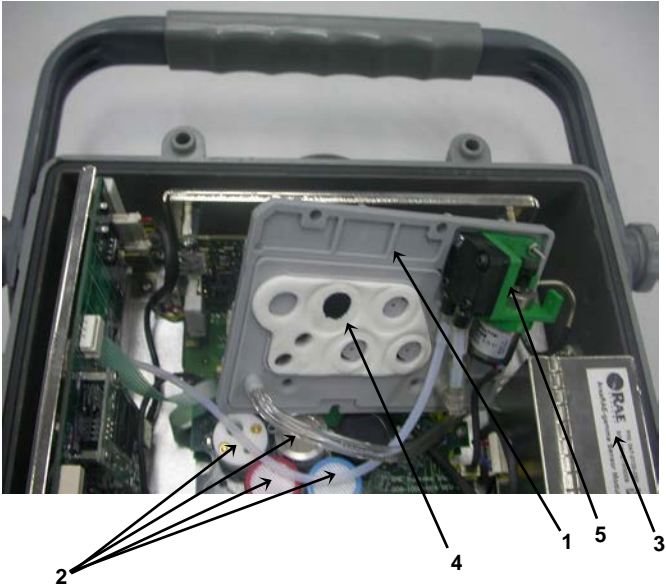
**NOTE:** The gamma radiation sensor on the AreaRAE Gamma and AreaRAE Gamma Steel does not rely on pumped air.

A single-chip microprocessor controls the operation of the alarm buzzer, LED, pump and light sensor. It measures the sensor readings and calculates the gas concentrations based on calibration to known standard gases. Collected data is stored in non-volatile memory so that it can be sent to a PC for record keeping. RS-232 transceivers provide a serial interface between the monitor and the serial port of a PC. A 2-line by 16-character LCD display is used to show the readings. The user interacts with the monitor through three keys on the front panel keypad.

A rechargeable lithium-ion battery or a six C-cell alkaline battery pack powers the monitor.

**Note:** The printed circuit board of the monitor is connected to the battery pack even when the power is turned off. Therefore, it is important to disconnect the battery pack before servicing or replacing sensors or other components inside the monitor. Severe damage to the printed circuit board may occur if the battery pack is not disconnected before servicing the unit.

## 6.0 Maintenance: AreaRAE & AreaRAE Gamma



**Figure 6-1** Internal Components of AreaRAE Gamma

1. Gas Plate
2. Gas sensors
3. Gamma Sensor
4. Charcoal filter
5. Pump



## 6.1 Battery Replacement

When the display shows a flashing message “Bat,” the battery requires recharging. The battery may be replaced in the field (in area known to be non-hazardous) if required. It is recommended to recharge the AreaRAE or AreaRAE Gamma monitor upon returning from fieldwork. A fully charged battery powers an AreaRAE for up to 24 hours of continuous operation. The charging time is less than 10 hours for a fully discharged battery. The built-in charging circuit is controlled by two-step constant voltage/constant current charging to prevent overcharging.



<p>To reduce the risk of ignition of hazardous atmospheres, recharge battery only in area known to be non-hazardous. Remove and replace battery only in area's known to be non-hazardous.</p>
---

## 6.2 Sensor Replacement

The toxic, combustible and oxygen sensors all have an expected operating life. Under normal operating condition, most sensors will lose their original sensitivity after the expected operating life and will need to be replaced.

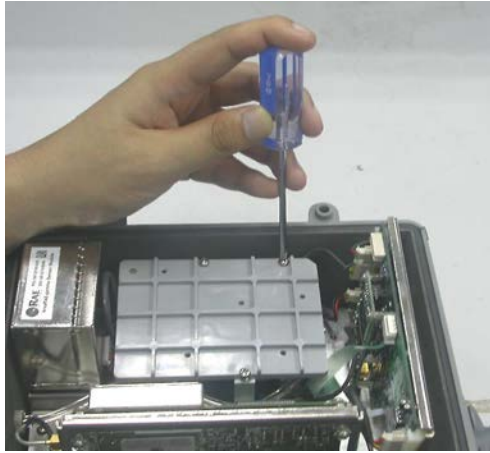
Each sensor module in AreaRAE and AreaRAE Gamma includes a non-volatile memory, which records the manufacturing date of the sensor. In the diagnostic mode, the microprocessor will check the date code and display the expiration date of each sensor. It is suggested that the user should replace the sensor when the current date exceeds the expiration date of a sensor.

### Sensor Replacement Procedure

The oxygen and combustible sensor both have unique sensor sockets in the AreaRAE. The toxic sensor socket in the AreaRAE allows plugging in any sensor selected from the series of toxic sensors offered by RAE Systems Inc.

1. Turn AreaRAE off.
2. Remove the battery pack. (See Section 3.2: Interchangeable Battery Packs.)
3. Open the monitor by removing the four hex screws that hold the front and back housing together:





**Figure 6-2** Gas Plate of AreaRAE



1      2      3      4      5

**Figure 6-3** Detailed Sensor Assembly of AreaRAE Gamma

1. PID sensor
2. Toxic sensor
3. LEL sensor
4. Gamma sensor (toxic sensor 2 in AreaRAE)
5. O<sub>2</sub> sensor

4. Refer to Figures 6-2 and 6-3: Carefully unscrew the three screws that hold down the gas plate to the analog PCB and sensors. Remove the gas plate.
5. Identify the location of a specific toxic sensor and remove the sensor by gently pulling the sensor upward.
6. Plug a new sensor into the empty sensor socket. Make sure that black line on the sensor label is lined up with the white marker on the PCB and the sensor pins are aligned with the socket before pushing down the sensor.
7. Replace the gas plate and tighten the three screws to hold down the sensors. Reconnect the battery pack. Replace the monitor cover.
8. Turn AreaRAE on. The microprocessor automatically recognizes the sensors installed and configure the monitor accordingly.

**NOTE:** The gamma radiation sensor installed in the AreaRAE Gamma does not usually need to be replaced unless it is damaged or malfunctioning. To replace the gamma sensor, remove the dummy sensor plug from the PCB and the gamma sensor module. Replace it with a new module and reconnect the dummy sensor plug on the PCB.

### **Special Bias Voltage for Toxic Sensors**

The NO toxic sensors require a special 300 mV bias voltage to operate. Only the first toxic sensor socket provides such a special bias voltage. Therefore, NO toxic sensor must be installed into the first toxic sensor socket (Tox1) in AreaRAE-Gamma.

In addition, there is a DIP switch or pin jumper located on the analog PCB next to the PID sensor. When an NO toxic sensor is plugged into the first toxic sensor socket, it is necessary to switch the jumper to the right to enable the bias voltage. During the power-on sequence, the microprocessor checks the sensor ID and the bias voltage. If the NO sensor is plugged into the wrong toxic sensor socket or the jumper is not switched on, an error message is displayed.

## 6.3 PID Sensor Cleaning

This section only applies to a monitor that is equipped with the PID detector option. During the course of normal operation, a film of gas vapor may build up inside the PID sensor module and the UV lamp. The rate at which the film develops depends on the type and concentration of the vapors being sampled. As a guide, it is recommended to clean the PID sensor module and lamp only when the PID is malfunctioning.

The sensor module is made of several components and is attached to the lamp housing unit.

If the lamp does not turn on, the monitor displays an error message of "Lamp" to indicate cleaning or replacing the lamp is required. Periodic cleaning of the lamp window also removes film deposits and restores lamp sensitivity. Care must be exercised when cleaning the window surface so that it is not damaged.

1. Turn off the AreaRAE, make sure it has been disconnected from the battery charger, and then remove the battery pack.
2. Refer to Figure 6-1: Open the monitor cover by unscrewing the four hex screws that holds the front and back housing together.
3. Refer to Figures 6-2 and 6-3: Carefully unscrew the three screws that hold down the gas plate to the analog PCB and sensors. Remove the gas plate.
4. Remove the shielding cap for the PID sensor. Gently pull out the PID sensor. Note the sensor is made of Teflon and stainless steel material.

## MAINTENANCE FOR AREARAE

---

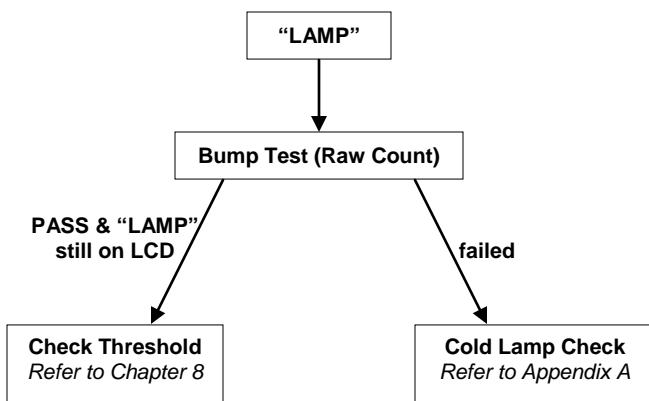
5. Dip the entire PID sensor into GC-grade methanol. It is highly recommended that an ultrasound bath to be used to clean the sensor for at least 3 minutes. Then dry the sensor thoroughly.
6. If the lamp is operational, use a cotton swab to clean the flat window surface with GC-grade methanol. If the lamp does not turn on, remove the UV lamp.
7. Install a new lamp, avoiding contact with the flat window surface.
8. Reinstall the PID sensor. Install the shielding cap.
9. Refer to Figures 6-2 and 6-3, install the gas plate and tighten the four screws to hold down the sensors.
10. Replace the four hex screws holding the instrument housing together.
11. Reinstall the battery pack.
12. Calibrate the instrument prior to placing it back into service.

## 6.4 Taking Care of the Lamp

During the course of regular operation, the UV lamp will become contaminated. Therefore, the lamp requires periodic cleaning. The “Lamp” error is an indication of a problem with the lamp current. A dirty or contaminated sensor often causes high readings of the VOC sensor. A weak or inoperative lamp often causes low readings or no response to test gas. If the UV lamp is on while the error message persists, then it is necessary to adjust the lamp threshold. Please refer to Chapter 8 for details of adjusting the threshold level for the UV lamp.

### CAUTION!

Never touch the window surface with fingers or anything which may leave a film. Water degrades window surfaces, especially the 11.7 eV lamp window.



## 6.5 Sampling Pump Replacement

The sampling pump is positive displacement piston pump. When approaching the end of the specified lifetime of the pump, it will consume higher amount of energy and reduce its sample draw capability significantly. When this occurs, it is necessary to replace the pump.

1. Turn off the AreaRAE, and remove the battery pack.
2. Refer to Figures 6-1, 6-2 and 6-3. Remove the four hex screws holding the instrument housing together.
3. Carefully unscrew the three screws that hold down the gas plate to the analog PCB and sensors.
4. Remove the gas plate.
5. Carefully loosen the connector.
6. Remove the two screws that hold the pump assembly to the gas plate.
7. Unscrew the two screws that holding the pump to the PCB.
8. Disconnect the Tygon tubing that connects the pump to the gas inlet port.
9. Replace with a new pump assembly.
10. Connect the Tygon tubing to the gas inlet port.
11. Reattach the pump and screw down the pump assembly to the analog PCB.
12. Replace the gas plate and tighten the three screws to hold down the sensors.
13. Reattach the hex screws holding the instrument housing together.
14. Reinstall the battery pack.

### Dust Filter

The dust filter's function is to reduce the level of dust and moisture entering the sensors and the pump. By replacing the dust filter routinely, it can reduce cost of maintenance on the pump or replacement of the sensors.

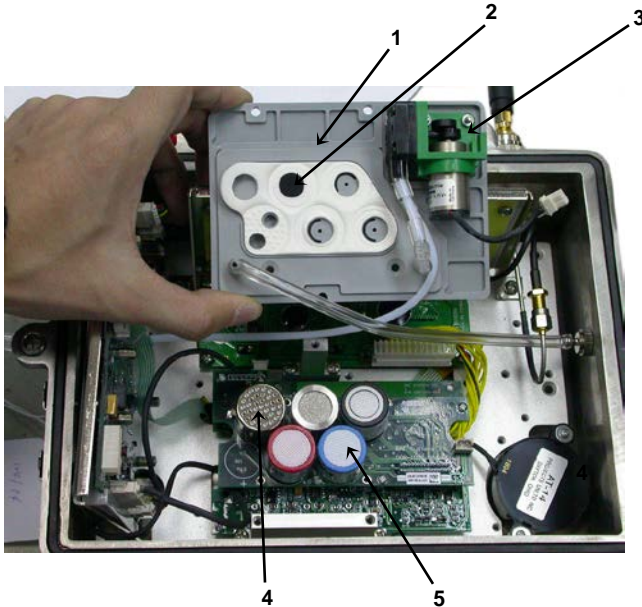


## MAINTENANCE FOR AREARAE

---

The dust filter should be changed when build-up of water droplets or dust is observed. To change the dust filters, pull apart the lock connections and replace the dust filter.

## 7.0 Maintenance: AreaRAE Steel & AreaRAE Steel Gamma



**Figure 7-1** Internal Components of the AreaRAE Steel

1. Gas Plate
2. Dust Filter
3. Pump
4. Sensors
5. Toxic 2 sensor (replaced by gamma sensor in AreaRAE Steel Gamma)

**⚠ WARNING ⚠**

To reduce the risk of ignition of hazardous atmospheres, open the enclosure only in areas known to be non-hazardous.

## 7.1 Opening The AreaRAE Steel

1. Turn off the AreaRAE Steel or AreaRAE Gamma Steel, and disconnect it from its power source.
2. Remove the antenna by unscrewing it.
3. Remove the handle.
4. Remove the four screw-in feet by turning them counterclockwise.
5. Remove the battery: Loosen the four Philips screws and lift off the cover plate. Pull out the battery by holding the ends of the black ribbon.
6. Remove all six hex screws that hold the front and back halves together.
7. Separate the two halves. If necessary, use a coin or screwdriver to gently pry between the mating flanges where the hex screws go. Do not use a sharp tool.

## 7.2 Reassembling The AreaRAE Steel

1. Place the main housing face-down so the O-ring groove is facing up.
2. Make sure the O-ring is installed and is placed inside the groove without twisting.
3. Place the back of the housing onto the front, carefully checking that the O-ring is in place. Align all the mounting holes.
4. Push down on the back of the housing to see if both indexed bushings on the side mounting tab engage into the corresponding index holes. Adjust the alignment if the mounting holes are not aligned.
5. Place the first hex screw into the side mounting hole where the index bushing is installed.
6. Hand-tighten the screw two turns into the receptacle.
7. Place the second screw into the mounting hole opposite from the first one and hand-tighten it two turns.
8. Place the rest of the screws in the opposite side and hand-tighten them by two turns until all screws are in place.
9. Hand-tighten each screw a few more turns in alternation until all screws are hand-tightened.

## MAINTENANCE FOR AREARAE STEEL

---

10. Use a hex wrench to tighten each screw in alternation by 1/4 turn until all screws are tight.
11. Replace the handle.
12. Replace the four feet.
13. Replace the antenna.
14. Replace the battery and its cover plate.
15. Reconnect power to the AreaRAE Steel.

## 7.3 Battery Replacement

When the display shows a flashing message “Bat,” the battery requires recharging. The battery may be replaced in the field (in areas known to be non-hazardous) if required. It is recommended to recharge the AreaRAE Steel monitor upon returning from fieldwork. A fully charged battery powers the AreaRAE Steel monitor for up to 24 hours’ continuous operation. The charging time is typically less than 10 hours for a fully discharged battery. The built-in charging circuit is controlled by two-step constant voltage/constant current charging to prevent overcharging.



<p>To reduce the risk of ignition of hazardous atmospheres, recharge the battery only in areas known to be non-hazardous. Remove and replace battery only in areas known to be non-hazardous.</p>
---

## 7.4 Sensor Replacement

The toxic, combustible and oxygen sensors all have an expected operating life. Under normal operating conditions, most sensors lose their original sensitivity after the expected operating life and will need to be replaced.

Each sensor module in the AreaRAE Steel includes a non-volatile memory, which records the manufacturing date of the sensor. The microprocessor checks the date code and display the expiration date of each sensor. It is suggested that the user should replace the sensor when the current date exceeds the expiration date of a sensor.

### Sensor Replacement Procedure

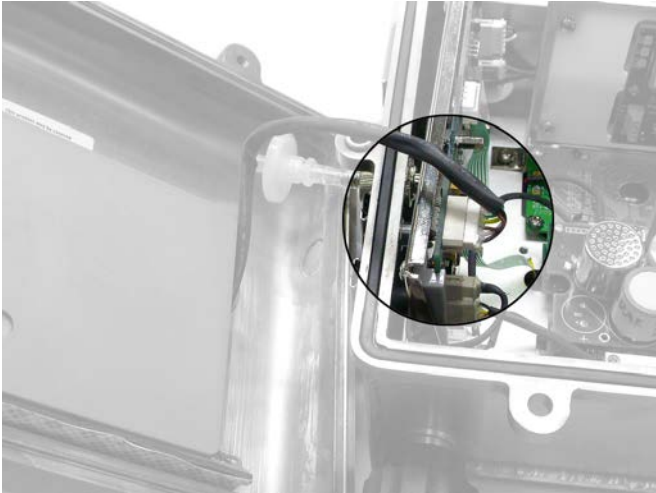
The oxygen and combustible sensor each has a unique sensor socket in the AreaRAE Steel. The two toxic sensor sockets allow plugging in any two sensors selected from the series of toxic sensors offered by RAE Systems Inc.

1. Turn the AreaRAE Steel off.
2. Remove the battery pack. (See Section 3.2: Interchangeable Battery Packs.)
3. Open the monitor housing by removing the six hex screws that hold the housing together.



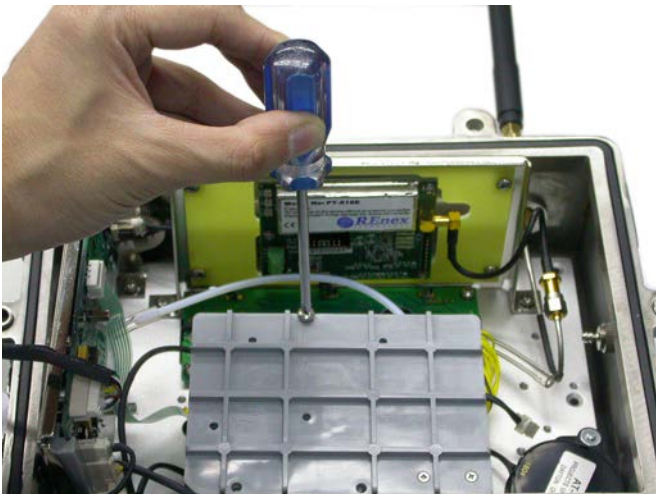
**Figure 7-2** Housing hex screw

4. Disconnect the rear battery cover and then disconnect the battery from the printed circuit board.



**Figure 7-3** Battery connection

5. Remove the three screws that hold down the gas piping plate to the printed circuit board. Remove the gas piping plate.

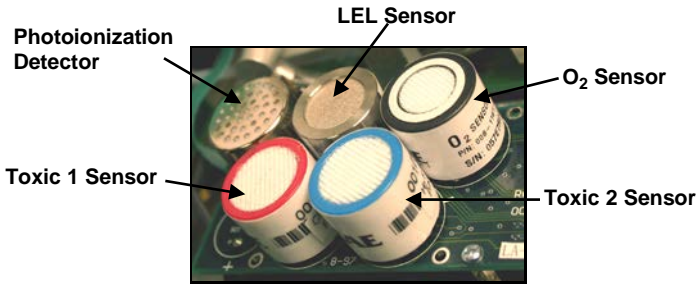


**Figure 7-4** Gas piping plate removal

## MAINTENANCE FOR AREARAE STEEL

---

6. Identify the location of a specific toxic sensor and remove the sensor by gently pulling the sensor upward. Note: In the AreaRAE Gamma and AreaRAE Gamma Steel, the gamma radiation sensor replaces the Toxic 2 sensor.



**Figure 7-5** Sensor locations

7. Plug a new sensor into the empty sensor socket. Make sure that black line on the sensor label is lined up with the white marker on the PCB and the sensor pins are aligned with the socket before pushing down the sensor.
8. Replace the gas piping plate and tighten the three screws to hold down the sensors.
9. Reassemble the AreaRAE Steel.
10. Connect the battery pack to the printed circuit board, place the battery in its compartment, and replace the cover plate and its four screws.
11. Turn the AreaRAE Steel on, and the monitor automatically recognizes the sensors installed and configures the monitor accordingly.

**NOTE:** The gamma radiation sensor installed in the AreaRAE Gamma Steel does not usually need to be replaced unless it is damaged or malfunctioning. To replace the gamma sensor, remove the dummy sensor plug from the PCB and the gamma sensor module. Replace it with a new module and reconnect the dummy sensor plug on the PCB.



### **Special Bias Voltage for Toxic Sensors**

The NO toxic sensors require a special 300 mV bias voltage to operate. Only the first toxic sensor socket provides such a special bias voltage. Therefore, NO toxic sensors must be installed into the first toxic sensor socket (Tox1) in AreaRAE-Gamma.

In addition, there is a dip switch or pin jumper located on the analog PCB next to the PID sensor. When an NO toxic sensor is plugged into the first toxic sensor socket, it is necessary to switch the jumper to the right to enable the bias voltage. During power on sequence, the microprocessor will check the sensor ID and the bias voltage. If the NO sensor is plugged into the wrong toxic sensor socket or the jumper is not switched on, an error message will be displayed.

## 7.5 PID Sensor Cleaning/Replacement

This section only applies to a monitor that is equipped with the PID detector option. During the course of normal operation, a film of gas vapor may build up inside the PID sensor module and the UV lamp. The rate at which the film develops depends on the type and concentration of the vapors being sampled. As a guide, it is recommended to clean the PID sensor module and lamp only when the PID is malfunctioning. The sensor module is made of several components and is attached to the lamp housing unit. If the lamp does not turn on, the monitor displays an error message of "Lamp" to indicate cleaning or replacing of the lamp is required. Periodic cleaning of the lamp window will also remove film deposits and restore lamp sensitivity. Care must be exercised when cleaning the window surface so that it will not be damaged.

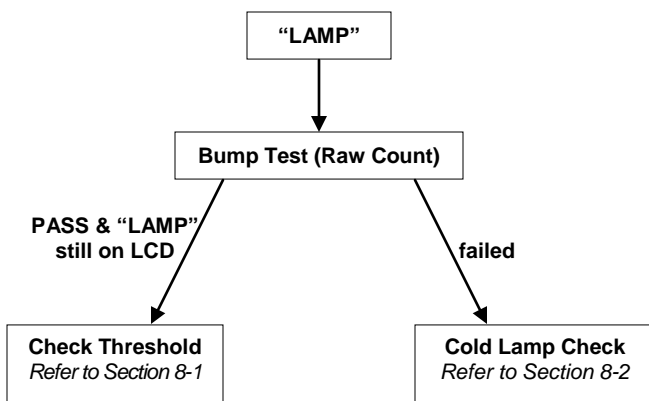
1. Turn off the AreaRAE Steel. Make sure it has been disconnected from the battery charger, and then remove the battery pack.
2. Open the monitor cover, and carefully remove the gas piping plate from the printed circuit board and sensors.
3. Remove the shielding cap for the PID sensor. Gently pull out the PID sensor. Note: The sensor is made of Teflon and stainless steel material.
4. Dip the entire PID sensor into GC-grade methanol. It is highly recommended that an ultrasound bath to be used to clean the sensor for at least 3 minutes. Then dry the sensor thoroughly.
5. If the lamp is operational, use a cotton swab to clean the flat window surface with GC-grade methanol. If the lamp does not turn on remove the UV lamp.
6. Install a new lamp, avoiding contact with the flat window surface.
7. Reinstall the PID sensor. Install the shielding cap.
8. Replace the gas piping plate. Reattach the instrument housing and reinstall the battery pack.
9. Calibrate the instrument prior to placing it back into service.

## 7.6 Taking Care of the Lamp

During the course of regular operation, the UV lamp becomes contaminated. Therefore, the lamp requires periodic cleaning. The “Lamp” error is an indication of a problem with the lamp current. A dirty or contaminated sensor often causes high readings of the VOC sensor. A weak or inoperative lamp often causes low readings or no response to test gas. If the UV lamp is on while the error message persists, then it is necessary to adjust the lamp threshold. Refer to Chapter 8 for details of adjusting the threshold level for the UV lamp.

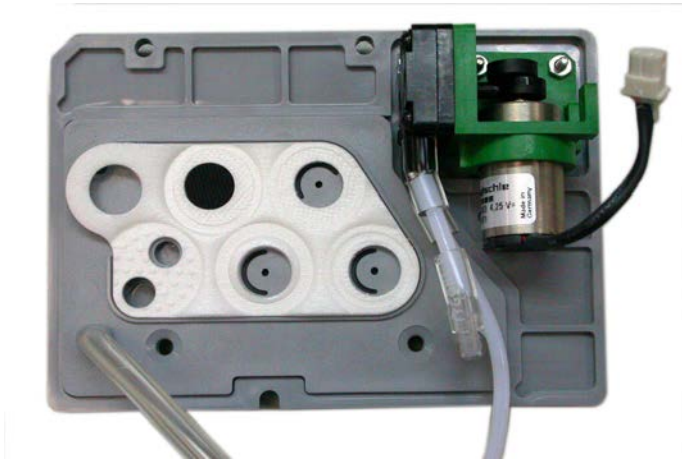
### CAUTION!

Never touch the window surface with fingers or anything that may leave a film. Water degrades window surfaces, especially the 11.7 eV lamp.



## 7.7 Sampling Pump Replacement

The sampling pump is positive-displacement piston pump. When the pump approaches the end of its specified lifetime, it consumes higher amounts of energy and significantly reduces its sample-draw capability. When this occurs, it is necessary to replace the pump.



**Figure 7-6** Sampling pump on gas plate

1. Turn off the AreaRAE Steel, and remove the battery pack.
2. Open the housing, and then carefully remove the gas piping plate. The pump is attached to the gas plate.
3. Carefully loosen the connector.



**Figure 7-7** Gas plate connector

4. Disconnect the Tygon tubing that connects the pump to the gas inlet port.
5. Unscrew the two screws that hold the pump assembly to the gas plate.



**Figure 7-8** Gas plate screw

6. Replace the old pump assembly with a new one. Connect the Tygon tubing to the gas inlet port. Reattach the pump.
7. Replace the gas piping plate and tighten the three screws to hold down the sensors.
8. Reattach the hex screws holding the instrument housing together, and reinstall the battery pack.

### **Internal External Filter**

The internal External Filter's function is to reduce the level of dust and moisture entering the sensors and the pump. By replacing the internal External Filter routinely, it can reduce cost of maintenance on the pump or replacement of the sensors.

The internal External Filter should be changed when build-up of water droplets or dust is observed. To change the internal External Filter, pull apart the lock connections and replace the filter.

## 8. Troubleshooting

To aid diagnosing problems in the AreaRAE and AreaRAE Steel, this chapter summarizes possible problems and suggested solutions.

### 8.1 Possible Problems & Solutions

<b>Problem</b>	<b>Possible Reason</b>	<b>Possible Solution</b>
No power after charging battery	Drained battery Defective battery Microprocessor hang-up	Charge battery Replace battery Disconnect and then reconnect the battery to reset computer
No LED or LCD backlight	Defective LED or LCD backlight	Call authorized service center
Lost password	Forgot password	Call authorized service center
Buzzer inoperative	Defective buzzer	Call authorized service center
Reading abnormally high	Wrong calibration data Dirty sensor module Dirty External Filter Excessive moisture and/or water condensation Wrong correction factor	Calibrate with gas again Clean sensor module Replace External Filter Blow dry sensor module Check correction factor

(Continued)

## TROUBLESHOOTING

### Troubleshooting Continued

“Lamp” message during operation	Wrong threshold Dirty PID sensor Weak or defective PID lamp	Adjust lamp threshold Clean PID sensor Replace PID lamp
Reading abnormally low	Incorrect calibration Low sensitivity to the specific gas Wrong correction factor	Calibrate monitor Replace sensor Check correction factor
Read a small background value when there is no detectable gas	Sensor zero drifts The unit is out of battery power or disconnected, or the sensor was just plugged in	Do fresh air calibration (see section 4.4.1) Wait for the reading to stabilize
Reading jumps around randomly	Incorrect gas calibration Low sensitivity to calibration gas	Calibrate the sensor Clean PID Check Sensor
Cannot turn monitor off Corrupted characters on LCD	Microprocessor hang-up	Disconnect and reconnect battery to reset computer Call authorized service center
Calibration error message	No standard gas input	Make sure standard gas flows into monitor
“Bat” message in operation	Uncharged battery	Recharge battery
Full-scale measurement in humid environment	Dirty or wet sensor	Clean and dry sensor Replace External Filter
VOC measurement maxes out at certain level	Dirty PID sensor module Weak PID lamp	Clean lamp/sensor module Release with a new lamp Replace filter

(Continued)

### Troubleshooting Continued

Excessive pump noise No inlet air vacuum	Leaky inlet path Defective pump	Check inlet connection Replace with a new pump
Radio Communication	See Section 6.3 or 7.3.	
Reading jumps around randomly	Incorrect gas calibration Low sensitivity to calibration gas	
Cannot turn monitor off Corrupted characters on LCD	Microprocessor hang-up	
Calibration error message	No standard gas input	
"Bat" message in operation	Uncharged battery	
Full-scale measurement in humid environment	Dirty or wet sensor	
VOC measurement maxes out at certain level	Dirty PID sensor module Weak PID lamp	
Excessive pump noise No inlet air vacuum	Leaky inlet path Defective pump	
Radio Communication	See Section 6.3 or 7.3.	



## 8.2 Lamp Troubleshooting Details

### Cold Lamp Startup

The UV (ultraviolet) lamp is made of a glass envelope and a UV window on one end of the envelope. The lamp is filled with low-pressure gases. To turn on the lamp, a high-voltage electric field is applied from the outside of the glass envelope. The molecules inside the lamp are ionized and produce a glow discharge effect to generate the UV light. Because this UV lamp does not have an electrode inside the glass envelope, it requires a small amount of ions inside the lamp to initiate the glow discharge process.

If the UV lamp has not been used for a long period of time (longer than one month), the ion count inside the lamp becomes low. It may be slightly harder to turn on the UV lamp for the first time. If such a condition occurs, an error message "Lamp" appears in the monitor display during the power-on sequence. This phenomenon is more significant in 0.25" UV lamps used in the AreaRAE Steel, because of the relatively small lamp size.

To solve this problem, turn the monitor on and off a few times, and the lamp should turn on. Gently shaking the monitor also helps to initiate the glow discharge process. After the UV lamp is turned on for the first time, it should be easier to turn on the UV lamp the next time.

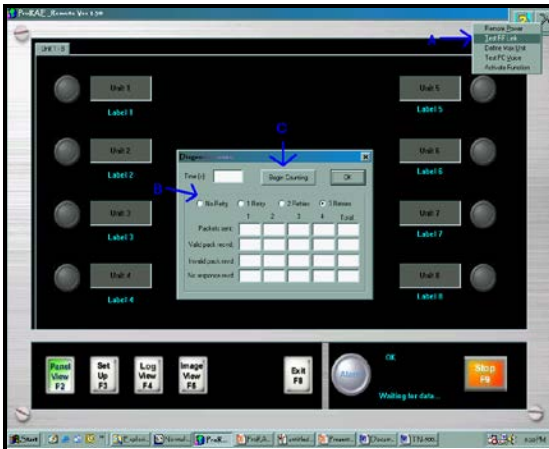
AreaRAEs feature a built-in sensing mechanism to monitor the status of the UV lamp. If the UV lamp is not on, the error message "Lamp" is displayed. It is possible that the UV lamp is actually on when the lamp error message appears. When the UV lamp becomes old, is changed, or the configuration file inside the AreaRAE monitor has been totally overwritten, the threshold level to determine lamp failure may be wrong and cause a false alarm. To eliminate this possibility, apply some VOC sense by putting a permanent marker (such as a Magic Marker) close to the inlet of the AreaRAE and see if the VOC raw count goes up.

## 8.3 Radio Communication Guide

This technical note provides procedures for identifying the cause of communication failure when using the ProRAE Remote Host Controller with the RAE Link Communication Kit. For complete setup and configuration, refer to RAE Systems Technical Note TN-170 and the quick reference guide provided with the ProRAE Remote Host Controller. Before verifying communication, refer to the spec sheet for the ProRAE Remote to ensure that the software is being used for the appropriate application.

### Troubleshooting Steps

1. **COMPATIBILITY:** Refer to the compatibility chart to verify that the firmware on the monitor and the version of the ProRAE Remote are compatible (Table 1).



**Figure 1.** Advanced Tools>>Test RF Link. Select the Advanced Tools icon (A) and choose “Test RF Link.” Choose the number of retries (B) and proceed to hit ‘Begin’ (C).

2. **POWER SUPPLY:** Make sure that the AreaRAE Steel and modem are both turned on. If the AreaRAE Steel is in “Low Bat” alarm, then communication will fail. The battery pack must have at least 6.6V available for proper communication. If the RAE Link battery fails, then the communication fails. RAE Systems strongly discourages the use of alkaline batteries if attempting communication

with the host. For optimal performance, use the rechargeable Lithium-ion batteries (part # 029-3053-000).

**Table 1.** Compatibility chart of ProRAE Remote and the AreaRAE Steel Firmware

Software Version	Firmware Versions			
	2.30	2.31	2.32	3.00
1.0	OK	OK	NO	NO
1.20	OK	OK	NO	NO
1.30	OK	OK	OK	OK
1.40	OK	OK	OK	OK

**ProRAE Remote Version 1.41 can support all firmware versions; however, some newer firmware versions are not compatible with ProRAE Remote Version 1.0 or 1.20.**

3. **MODE OF OPERATION:** The AreaRAE must be in regular operation mode. An antenna symbol should appear on the AreaRAE LCD, indicating the host is attempting to pull information from the unit. If any of the programming sub-menus have been entered, such as “Calibrate Monitor” then communication will fail.
4. **RADIO:** The “Radio” button on all sensing units must be activated. If pushing the “Radio” button does not make the red LED appear, then contact RAE Systems Service at tech@raesystems.com or 888-723-4800.
5. **COM PORT:** The same communication port that the RS232 cable is plugged into must be selected in the software. Within the ProRAE Remote proceed to “Set Up” (A)>> “Host” >> “RF Modem Port” (B) (Figure 2). Refer to Technical Note TN-170 for more detailed setup instructions including using USB ports. The chosen communication port must be functioning properly and cannot be occupied by another program. To verify the functionality of the communication port, RAE Systems Com Port Checker Kit (part number 029-0005-000) can be used. Simply follow the instructions provided with the Checker Program.

- 6. NETWORK ID:** In order for the sensing units to be able to communicate with the host controller, all components must be set up with the same Network ID. Refer to RAE Systems Technical Note TN-164 for more information on the Network ID. If there are any doubts about the Network ID or the need to change the Network ID arises, then contact RAE Systems Service. By providing the serial number of the RAE Link2 series modem or the AreaRAE units, the Network ID can be verified.



**Figure 2.** Set Up>>RF Modem Port. Press F2 (A) to activate “Set Up” dialog box, and proceed to select communication port that the RAE Link2 series modem is plugged into (B).

- 7. UNIT ID:** If multiple sensing units are attempting to communicate with the same Host, then the units must all have a different Unit ID.
- 8. MAX UNITS:** The unit ID for the AreaRAE can be 1 to 32. By default the number of units the software attempts to communicate with is 8. If any of the sensing units have a higher unit ID than 8, then the “Define Max Units” function must be initiated and the number of units increased. See Figure 3.



**Figure 3.** Advanced Tools >> Define Max Unit. Select the “Define Max Unit” from the “Advanced Tools” bar (A), and proceed to select the number of units the controller will attempt to communicate with (B).

If communication problems persist after going through steps 1 through 8, then contact RAE Systems Service at [tech@raesystems.com](mailto:tech@raesystems.com) or 888-723-4800.

**Updates:** Watch for updates of this and other technical and application notes on the Internet at [www.raesystems.com](http://www.raesystems.com).

**Disclaimer:** Actual setup and configuration may vary with computer manufacturers, models, operating systems, system hardware configurations, system software configurations, and application software. Refer to your computer hardware and software manuals for details.

## **9.0 RAE Systems Contact Information**

### **RAE Systems by Honeywell (Main Office)**

3775 N. First St. • San Jose, CA 95134-1708 • USA

*Tel:* 408.952.8200 • *Fax:* 408.952.8480

*Email:* raesales@raesystems.com

*Sales:* 877.723.2878 • *Web:* www.raesystems.com

*Technical Service:* 888.723.4800 • *Tech@raesystems.com*

### **RAE Systems Europe ApS**

Ørestads Boulevards 69

2300 Copenhagen S

Denmark

*Tel:* +45 86525155 • *Fax:* +45 86525177

orders@raeeurope.com

sales@raeeurope.com

service@raesystems.com

*Web:* www.raesystems.dk

### **RAE Systems UK Ltd**

D5 Culham Innovation Centre

Culham Science Centre

Abingdon, Oxon OX14 3DB

United Kingdom

*Tel:* +44 1865408368 • *Fax:* +44 1235531119

*Mobile:* +44 7841362693

*Email:* raeuk@raeeurope.com

### **RAE Systems France**

336, rue de la fée des eaux

69390 Vernaison

France

*Tel:* +33 4 78 46 16 65 • *Fax:* +33 4 78 46 25 98

*Email:* info-france@raeeurope.com

*Web:* www.raesystems.fr

**RAE BeNeLux BV**

Rijndal 20  
2904 DC Capelle a/d IJssel  
*Tel:* +31 10 4426149 • *Fax:* +31 10 4426148  
*Email:* info@rae.nl  
*Web:* www.rae.nl

The Netherlands  
Mr. Ing. P.M.J.B. Sieben, Mr. W.T. Terlouw  
*Mobile:* +31 646087592

Belgium and Luxembourg  
Mr. F. de Meyer  
*Mobile:* +32 497907394  
*Email:* f.demeyer@rae.be  
*Web:* www.rae.be

**RAE Systems Spain, s.l.**

Av. Remolar, 31  
08820 El Prat de Llobregat  
Spain  
*Tel:* +34 933 788 352 • *Fax:* +34 933 788 353  
*Mobile:* +34 687 491 106  
*Email:* mdelgado@raespain.com  
*Web:* www.raespain.com

**RAE Systems Middle East**

*M:* +45 2674 9791 or +97 50 429 1385  
mjorgensen@raesystems.com

**RAE Systems (Hong Kong) Ltd.**

Room 8, 6/F, Hong Leong Plaza • 33 Lok Yip Road  
Fanling, N.T, Hong Kong  
*Tel:* +852.2669.0828 • *Fax:* +852.2669.0803

## CONTACT INFORMATION

---

**SPECIAL NOTE:** If the monitor needs to be serviced, contact either:

- the **RAE Systems distributor** where the monitor was purchased; they will return the monitor on your behalf, or
- the **RAE Systems Technical Service department**. Before returning the monitor for service or repair, obtain a Returned Material Authorization (RMA) number for proper tracking of your equipment. This number needs to be on all documentation and posted on the outside of the box in which the monitor is returned for service or upgrade. ***Packages without RMA Numbers will be refused at the factory.***





**RAE Systems by Honeywell**  
**World Headquarters**  
**3775 N. First St.**  
**San Jose, CA 95134-1708 USA**  
**Phone: 408-952-8200**  
**Fax: 408-952-8480**  
**[www.raesystems.com](http://www.raesystems.com)**